

Processing example: inner shape of watch crown

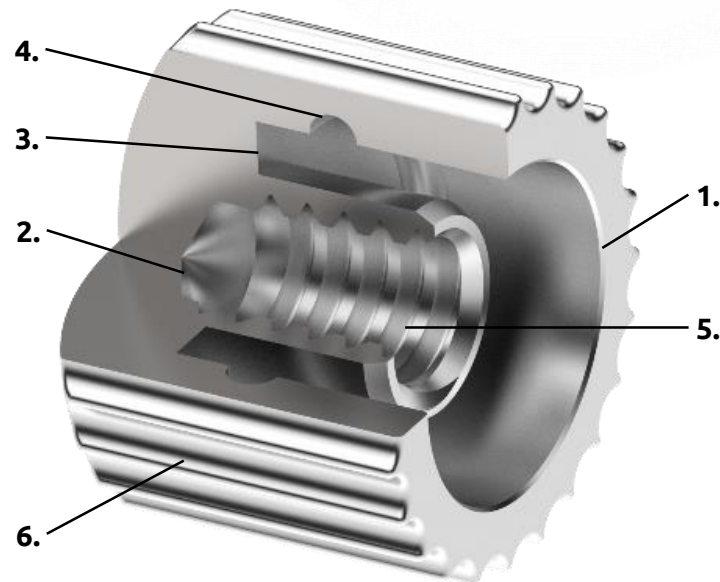

1. DRP - centering pointer

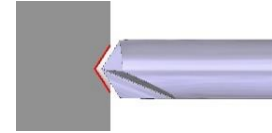

2. DRA - high performance chamfering drill

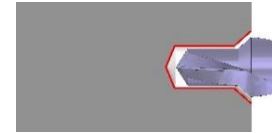

3. SXP - front grooving cutter

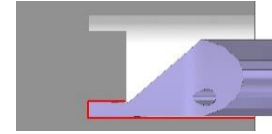

4. SDR - radius internal grooving cutter

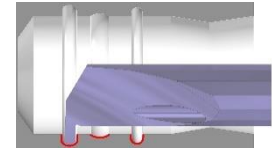

5a. SDU/SDV - threading cutter-partial and solid profile

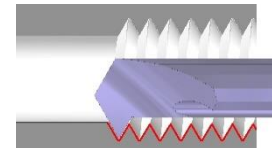

5b. WHC/WHS - thread whirler

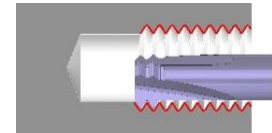

6. Tools for manufacturing of special profiles to customer specification

