



## CBN Inserts

- CBN H25
- CBN H35
- CBN H45
- CBN H65
- CBN H85
- CBN P25
- CBN P45
- CBN K65
- CBN K85
- CBN S85
- CBN X90
- CBN X95



Die and Mold Industry

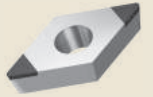
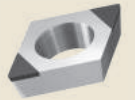

Automotive Mechanical Engineering

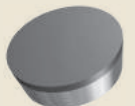

Medical Technology Micro Technology

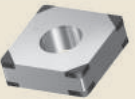

Aerospace Engineering

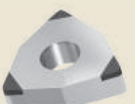
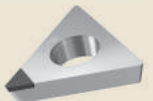



## Welcome to DTS - Diamond Tooling Systems GmbH!

Based in Kaiserslautern - Germany - we have specialized in the development, production and distribution of precision tools equipped with ultrahard cutting materials, such as PCD (polycrystalline Diamond), CVD-D (CVD thickfilm Diamond), UltraDiamond (monocrystalline binderless Diamond) and CBN (cubic boron nitride). As a leading manufacturer for tools with lasered cutting edges, we offer machining solutions in the areas of turning, milling, grooving, drilling, reaming, threading, and tool holding.

To be able to economically process ultra-hard cutting materials such as PCD, CVD-D and CBN on precision tools werealized early on that we would have to move away from the traditional production technology of „grinding“ to new technologies such as the „laser removal process“. This decision has contributed to the fact that our customers regard us, DTS GmbH, as the pioneer and leading manufacturer of lasered tools for machining.

Ultra-hard high-performance cutting materials have a key function in Metal-cutting manufacturing. Precision tool-equipped with ultra-hard cutting materials are products that require a great deal of explanation. The economical use of the cutting materials is only ensured if the machining process and the cutting material are coordinated with each other.

This is exactly where we at DTS - Diamond Tooling Systems GmbH - step in: Tools and processes are subjected to a comprehensive analysis by our experienced application engineers. Subsequently, the new process optimization is presented to the customer and in the next step, it is implemented in their production. Only in that way is it possible to exploit the optimum potential of our high-tech cutting materials.

Our experienced application engineers are also available to advise you during ongoing production. This close cooperation and mutual trust is the basis of our success.

With more than 25 years of optimization experience in the processing industry, this is where we see our strength!

## Overview

Ultrahard Cutting Materials at a Glance .....	04
Our CBN cutting materials .....	06
Application examples our cutting edges in use .....	07
Our Cutting Material Assignment according to Material use .....	08
Wiper Inserts, Functionality .....	09
ISO Code .....	10

## Products

CCGW .....	12
CDGW .....	14
CNGA .....	16
DCGW .....	18
DNGA .....	20
EPGW .....	24
RBGN .....	26
RCGW .....	26
RNGN .....	28
SCGW .....	30
SNGA .....	32
SNGN .....	34
TCGW .....	36
TNGA .....	38
TPGW .....	40
VBGW .....	42
VCGW .....	44
VNGA .....	46
VXGW .....	48
WCGW .....	50
WNGA .....	52

## Technical Attachment

Cutting Parameters .....	56
Formulas .....	60

## PASSION FOR DIAMOND...

ultrahard cutting materials at a glance

... is not just a slogan for us - we live this passion in our daily dealings with our customers and we are your partner when it comes to Diamond or CBN tools.

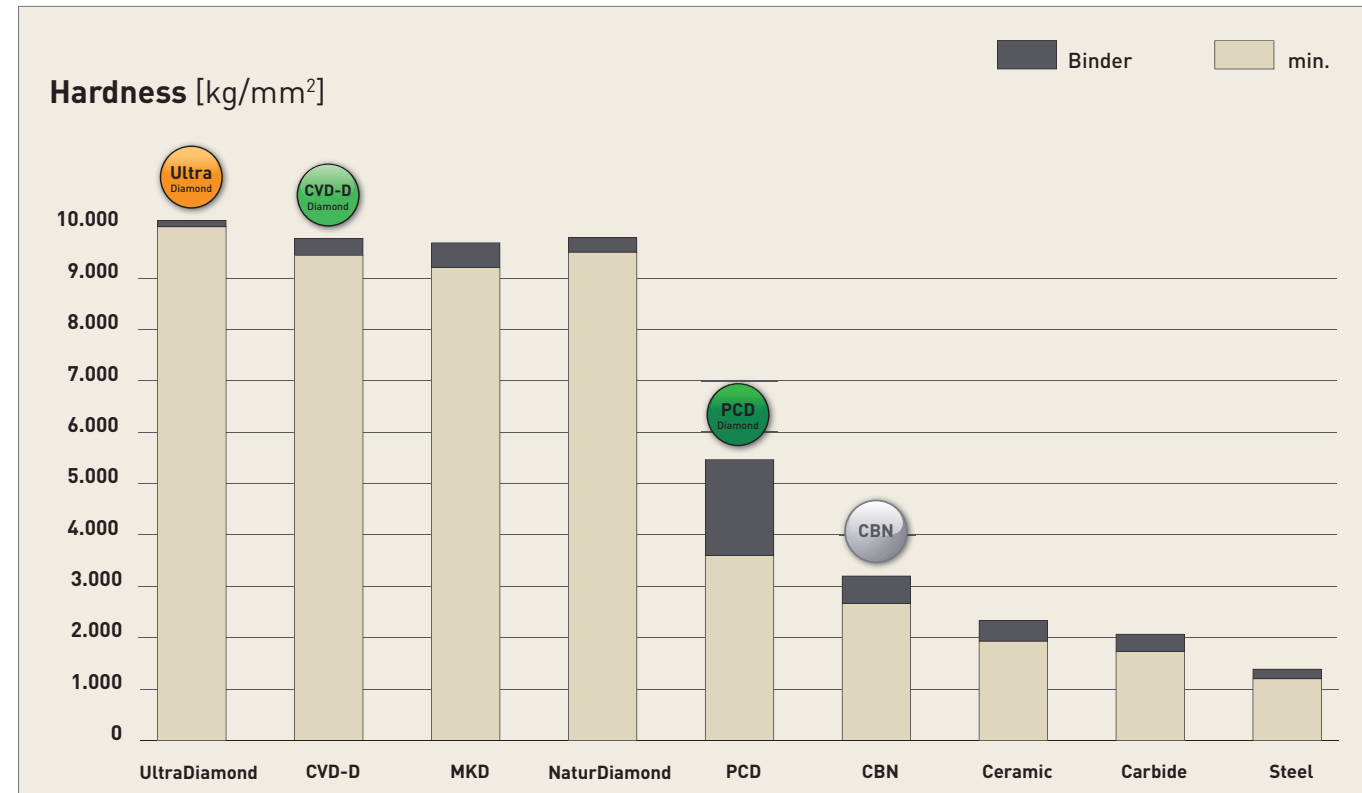

### Polycrystalline Diamond (PCD)

The well-known standard Diamond

PCD is a synthetically produced, extremely tough, intergrown mass of Diamond particles with random orientation in a Metal matrix. It is produced by sintering selected Diamond particles at high pressure and high temperatures.

Graphite is used as a catalyst so that the PCD crystals grow together. PCD has high thermal conductivity and good heat dissipation from the cutting area. In addition, PCD has the highest bending strength of all cutting materials bending strength of all cutting materials.

PCD is very well suited for machining aluminium with a Si content of up to 10% and/or other abrasive fillers. The hot hardness is approx. 750°C, the areas of application are similar to those of CVD thick film Diamond, but the high efficiency of CVD thick film Diamond comes into its own with hard-brittle materials or aluminium with a Si content of 10% or more.

### CVD thick film Diamond (CVD-D)

The star among Diamond Cutting Materials

For machining hard-brittle materials such as ceramics, glass, glass-ceramics, hard Metal, MMC and fibre composites such as CFK and GFK. Due to the lack of a bonding matrix, the Diamond content is much higher than with PCD. In the group of ultra-hard cutting materials, the binderless CVD-D is one of the hardest, artificially produced Diamond cutting materials.

CVD-D is characterised by high hardness and high wear resistance. These properties make CVD-D the perfect cutting material for machining abrasive materials. Compared to PCD, which is damaged by the abrasive particles due to its soft metallic binder phase, the CVD-D cutting edge remains stable due to its binderless anchoring in the Diamond matrix.

If CVD-D is used correctly, the service life can be increased by up to 10 times (and even more) compared to PCD!

### Binderless Diamond (UltraDiamond)

The hardest single Crystal

Single-crystal elements are laser-cut from Diamond blanks in a defined orientation using laser segmentation technology. This new technology makes it possible, in addition to polycrystalline cutting materials such as PCD and CVD-D, to also braze a monocrystal (UltraDiamond) under high vacuum on any tool carrier. Compared to PCD, the tool life can be increased by approx. 15 to 25 times and compared to CVD-D by approx. 2 to 5 times.

The areas of application are similar to PCD and CVD-D, but this monocrystalline cutting material offers a further significant increase in tool life in all applications where PCD and CVD-D reach the limits of economic viability. The UltraDiamond cutting material makes economical machining of very hard, highly brittle materials such as Ceramics, glass, glass-Ceramics and hard metals with low cobalt binder and nickel binder (<10%) possible. Ceramics, glass, glass-ceramics and hard metals with low cobalt binder and nickel binder (<10%).

### Polycrystalline Cubic Boron Nitride (CBN)

Chemically resistant and stable at high temperatures

CBN is stable up to 1,400°C. Boron nitride powder is the starting point for the production of CBN, which has been available since the late 1960s. It is produced under high pressure as well as at temperatures of over 1,500°C and is specially adapted to the final application through many different substrates.

Today, CBN is considered the second hardest material after Diamond cutting materials!

The applications of CBN are in the automotive industry, aerospace, tool and mould making and mechanical engineering. The wide spectrum as a cutting and abrasive material includes hardened Steels, Cast Iron, chilled Cast Iron, sintered materials, stellite, nickel and cobalt-based superalloys. In many applications, cubic boron nitride is preferred over Diamond cutting materials because it is absolutely stable in air at temperatures up to 1,400°C. Diamond, on the other hand, starts to decompose at a temperature of about 750°C.

Compared to PCD, CBN is also characterised by its chemical resistance to ferrous materials.



# Our cutting materials

and their main areas of application at a glance

CBN is now considered the second hardest material after Diamond cutting materials!

CBN-H

Our CBN grade-H is designed for the machining of hardened Steels up to 72 HRC

**H25**

• designed for the smooth cut

**H35|45|65**

• are the all-rounders for the smooth to heavily interrupted cut - 1. Choice ist CBN H65

**H85**

• was specially developed for the highly interrupted cut

CBN-P

The CBN grade-P has been specially developed for turning sintered materials. Among other things, you can machine these materials with this CBN grade:

- Sintered steel
- (\*hardened sintered steel can be machined with our CBN-H grades)

**P25**

• for smooth and slightly interrupted cut

**P45**

• for light to heavy interrupted cut

CBN-K

The CBN grade K has been specially developed for high-speed turning and milling of cast materials. Among other things, you can machine these materials with this CBN grade:

- Grey Cast Iron
- Spheroidal graphite Cast Iron
- Lamellar ball cast joints

**K65**

• our all-rounder for the smooth to heavily interrupted cut

**K85**

• for light to heavy interrupted cut

CBN-S

The CBN grade S has been specially developed for turning and milling difficult-to-machine aerospace materials. Among other things, you can machine these materials with this CBN grade:

- Ni, Co, Fe & Cr alloys
- Inconel 718

**S85**

• our all-rounder for smooth to heavily interrupted cuts

CBN-X

The CBN grade-X has been specially developed for hard turning and hard milling of tool Steels up to a hardness of 72HRC. Among other things, you can machine these materials with this CBN grade:

- HSS
- ASP and further PM Steels
- Cold work tool Steels
- Hot work tool Steels
- Solid carbide >20%Co
- Solid carbide steel connections

**X90**

• for smooth and slightly interrupted cut

**X95**

• for light to heavy interrupted cut

# Application examples

our cutting edges in use

Not only theory - we would like to show you our tools in action. Below you will find a selection of our CBN application videos. Click on the QR code for more information and the video.

Also visit our YouTube Channel at [dts-gmbh!](https://www.youtube.com/dts-gmbh)

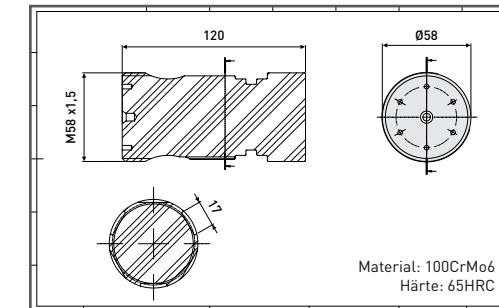
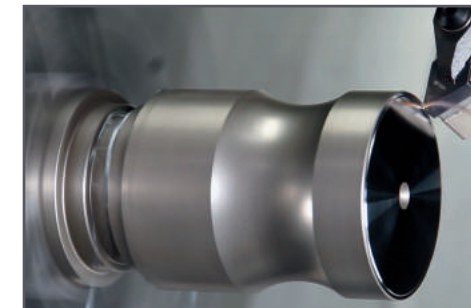

**Hard turning**  
100CrMo6 65HRC

Here you can see the video!

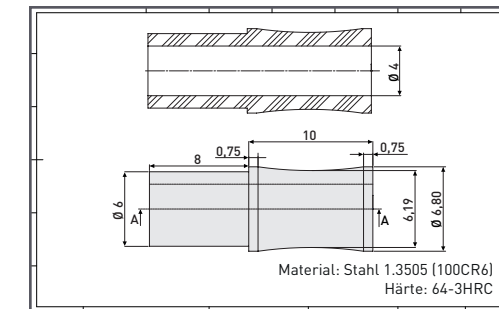

**Hard finishing**  
Steel 1.3505 64-3HRC

Here you can see the video!

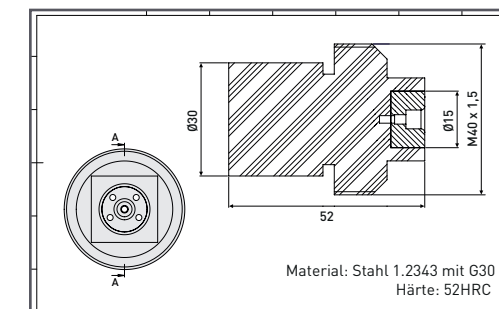

**Hard turning**  
Steel 1.2343 52HRC

Here you can see the video!

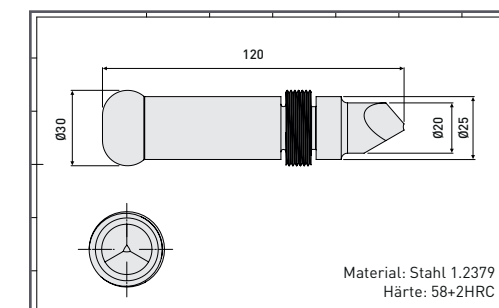

**Hard turning**  
Steel 1.2379 58+2HRC

Here you can see the video!

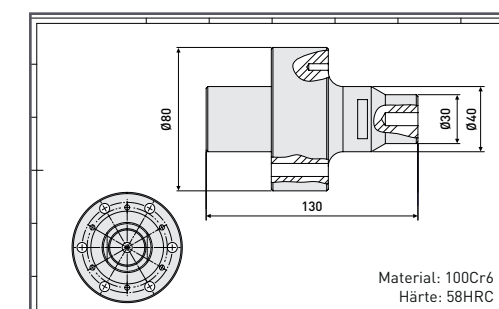
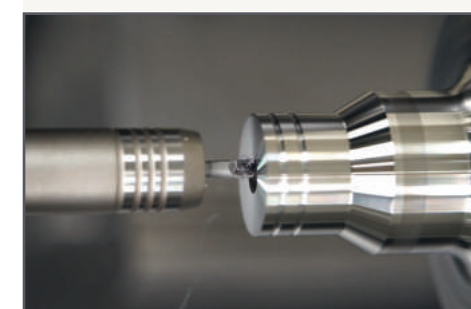

**Inside boring**  
100Cr6 58HRC  
MiniTool with CDGW 040102

Here you can see the video!

# Our Cutting Material Assignment

about the materials

You cannot find your material in the table?  
We are glad to help you by phone or by mail!

Phone: +49 (0) 6301 32011-0  
Mail: info@Diamond-toolingsystems.com

		DTS CBN Types						
		1. Choice	Alternative					
ISO	Materials	CBN-P	CBN-K	CBN-S	CBN-H	CBN-X		
H	Cold Work Steel, hardened up to 72 HRC				<input type="radio"/>	<input checked="" type="radio"/>		
	PM- Steels (ASP, CPM, Vanadis, Böhler)				<input type="radio"/>	<input checked="" type="radio"/>		
	Steel, hardened to 72 HRC				<input checked="" type="radio"/>	<input type="radio"/>		
	Hot Work Steel, hardened up to 72 HRC				<input type="radio"/>	<input checked="" type="radio"/>		
	Tool Steel, hardened up to 72 HRC				<input type="radio"/>	<input checked="" type="radio"/>		
P	Sintered Steel	<input checked="" type="radio"/>				<input type="radio"/>		
	Sintered Steel, hardened	<input type="radio"/>			<input checked="" type="radio"/>	<input type="radio"/>		
K	Grey Cast Iron (GG)		<input checked="" type="radio"/>	<input type="radio"/>				
	Ductile Cast Iron (GGG)		<input checked="" type="radio"/>	<input type="radio"/>				
	Shell Chilled Cast Iron	<input type="radio"/>			<input checked="" type="radio"/>			
S	Ni-, Co-, Fe- u. Cr-Alloys			<input checked="" type="radio"/>		<input type="radio"/>		
	Titanium Alloys			<input checked="" type="radio"/>		<input type="radio"/>		
M	Stainless Steel, hardened				<input type="radio"/>	<input checked="" type="radio"/>		
N	Carbide, > 20% Co*	<input type="radio"/>				<input checked="" type="radio"/>		
	* for the machining of Carbides							
	we recommend the use of							
	CVD-D Cutting edges see Catalogue 01							

# Wiper Indexable Inserts

Functionality

## Wiper Indexable Inserts:

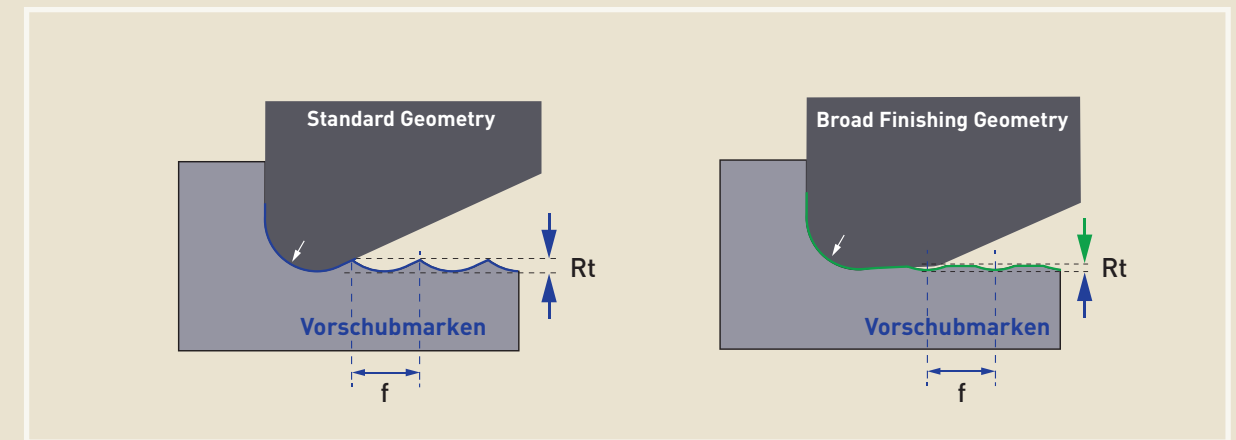

### Advantages when using Wiper Geometries

By using the same feed rate a 2-4 times better surface quality can be obtained or with a 2-4 times higher feed rate the same surface quality can be reached.

To get the wiper geometry into cutting condition please use the following lead angles at the machine:

**C and W Type: 95°**

**D Type: 93°**

CCGW ...  
(Z2)



Page 12

CNGA ...  
(Z2)

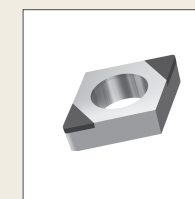

Page 16

DCGW ...  
(Z2)

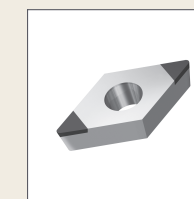

Page 18

WNGA ...  
(Z3)



Page 52

T N G A 16 04 08

Shape

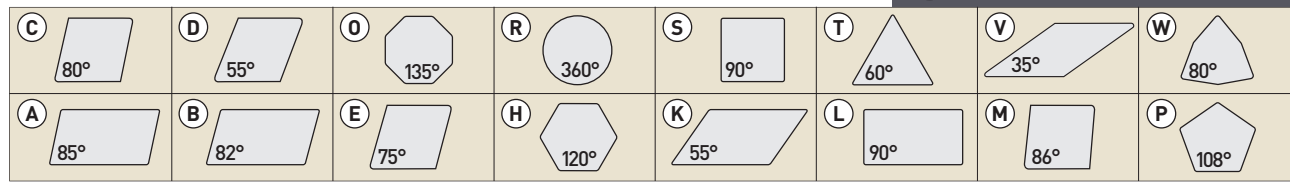

T N G A 16 04 08

Clearance

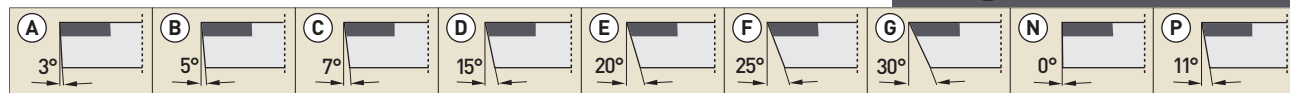

T N G A 16 04 08

Tolerance [mm]

	m	s	d		m	s	d
A	±0,005	±0,025	±0,025	J	±0,005	±0,025	±0,05 → ±0,15
F	±0,005	±0,025	±0,013	K	±0,013	±0,025	±0,05 → ±0,15
C	±0,013	±0,025	±0,025	L	±0,025	±0,025	±0,05 → ±0,15
H	±0,013	±0,025	±0,013	M	±0,08 → ±0,20	±0,130	±0,05 → ±0,15
E	±0,025	±0,025	±0,025	N	±0,08 → ±0,20	±0,25	±0,05 → ±0,15
G	±0,025	±0,130	±0,025	U	±0,13 → ±0,38	±0,130	±0,08 → ±0,15

\*[M, N, U] The exact tolerance depends on the size of the insert.

T N G A 16 04 08

Insert Type

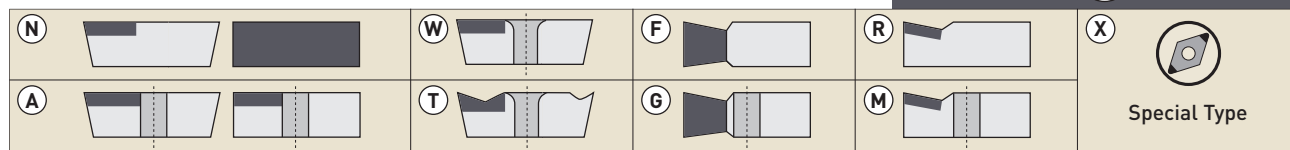

T N G A 16 04 08

Insert size [mm]

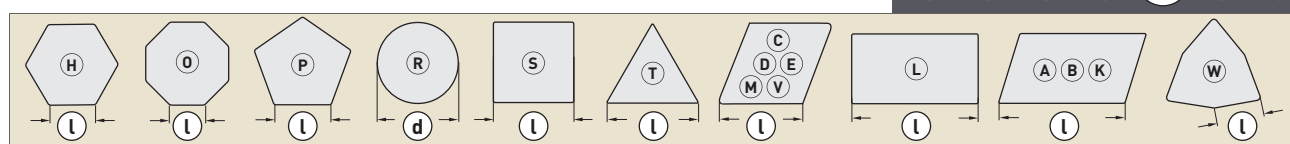

T N G A 16 04 08

Insert size [mm]

01 S=1,59   0T1 S=1,98   02 S=2,38   03 S=3,18   0T3 S=3,97   04 S=4,76   05 S=5,56   06 S=6,35

By numbers below 10 a 0 is added in at the front. Decimals remain unconsidered (for example: 4,76 = 04)

T N G A 16 04 08

Corner configuration [mm]

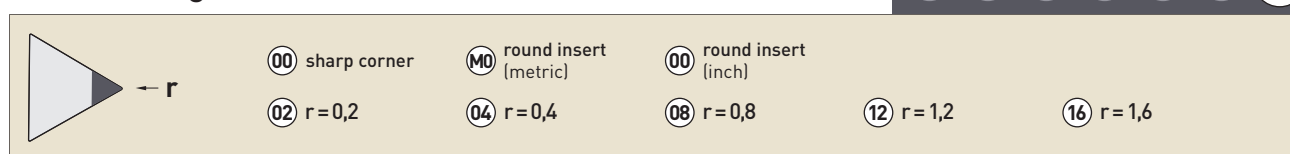

Large grid area for taking notes.

# CCGW

edge tipped

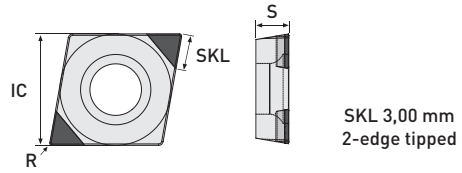
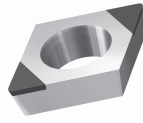

SKL 3,00 mm  
2-edge tipped

Standard

Scharf

Wiper

ISO Code	IC	S	R	P25	P45	K65	K85	S85
				Item No.	Item No.	Item No.	Item No.	Item No.
CCGW 060201	6,35	2,38	0,10			TI5510-0139		
CCGW 060202	6,35	2,38	0,20	TI5510-0140	TI5510-0141	TI5510-0142	TI5510-0143	TI5510-3102
CCGW 060204	6,35	2,38	0,40	TI5510-0145	TI5510-0146	TI5510-0147	TI5510-0148	TI5510-3104
CCGW 060208	6,35	2,38	0,80	TI5510-0150	TI5510-0151	TI5510-0152	TI5510-0153	TI5510-3106
CCGW 09T301	9,525	3,97	0,10			TI5510-1205		
CCGW 09T302	9,525	3,97	0,20	TI5510-0160	TI5510-0161	TI5510-0162	TI5510-0163	TI5510-3112
CCGW 09T304	9,525	3,97	0,40	TI5510-0165	TI5510-0166	TI5510-0167	TI5510-0168	TI5510-3114
CCGW 09T308	9,525	3,97	0,80	TI5510-0170	TI5510-0171	TI5510-0172	TI5510-0173	TI5510-3116
CCGW 120402	12,70	4,76	0,20	TI5510-0180	TI5510-0181	TI5510-0182	TI5510-0183	TI5510-3122
CCGW 120404	12,70	4,76	0,40	TI5510-0185	TI5510-0186	TI5510-0187	TI5510-0188	TI5510-3124
CCGW 120408	12,70	4,76	0,80	TI5510-0190	TI5510-0191	TI5510-0192	TI5510-0193	TI5510-3126
CCGW 120412	12,70	4,76	1,20	TI5510-0195	TI5510-0196	TI5510-0197	TI5510-0198	TI5510-3128
CCGW 060202-F	6,35	2,38	0,20			TI5510-2602		
CCGW 060204-F	6,35	2,38	0,40			TI5510-2604		
CCGW 09T302-F	9,525	3,97	0,20			TI5510-2612		
CCGW 09T304-F	9,525	3,97	0,40			TI5510-2614		
CCGW 09T302 R/L-W	9,525	3,97	0,20	TI5510-0205	TI5510-0206	TI5510-0207	TI5510-0208	
CCGW 09T304 R/L-W	9,525	3,97	0,40	TI5510-0210	TI5510-0211	TI5510-0212	TI5510-0213	TI5510-3144
CCGW 09T308 R/L-W	9,525	3,97	0,80	TI5510-0215	TI5510-0216	TI5510-0217	TI5510-0218	TI5510-3146
CCGW 120404 R/L-W	12,70	4,76	0,40	TI5510-0225	TI5510-0226	TI5510-0227	TI5510-0228	TI5510-3154
CCGW 120408 R/L-W	12,70	4,76	0,80	TI5510-0230	TI5510-0231	TI5510-0232	TI5510-0233	TI5510-3156
CCGW 120412 R/L-W	12,70	4,76	1,20	TI5510-0235	TI5510-0236	TI5510-0237	TI5510-0238	TI5510-3158

### Application range:

- CBN-P Sintered Steel ...
- CBN-K Grey Cast Iron (GCI), Ductile Cast Iron (DCI) ...
- CBN-S Ni-, Co-, Fe- and Cr-Alloys, Titanium, Titanium Alloys ...
- CBN-H Steel hardened up to 72 HRC, Cast Iron hardened ...
- CBN-X Tool Steel hardened, Stellite, Stainless Steel hardened, powder metallurgical Steel ...

You will find further application ranges in the detailed overview on page 8.

Detailed informations about cutting parameters and cooling can be found on page 56.

- continuous cut
- light interrupted cut
- heavy interrupted cut

Allrounder - hardened Steels							Version
H25	H35	H45	H65	H85	X90	X95	
	2. Alternative	1. Alternative	1. Choice				
Item No.	Item No.	Item No.	Item No.	Item No.	Item No.	Item No.	Item No.
TI5010-0139					TI5910-0139		2-edge tipped
TI5010-0140	TI5010-3102	TI5010-0141	TI5010-0142	TI5010-0143	TI5910-0142	TI5910-0143	2-edge tipped
TI5010-0145	TI5010-3104	TI5010-0146	TI5010-0147	TI5010-0148	TI5910-0147	TI5910-0148	2-edge tipped
TI5010-0150	TI5010-3106	TI5010-0151	TI5010-0152	TI5010-0153	TI5910-0152	TI5910-0153	2-edge tipped
TI5010-1205					TI5910-1205		2-edge tipped
TI5010-0160	TI5010-3112	TI5010-0161	TI5010-0162	TI5010-0163	TI5910-0162	TI5910-0163	2-edge tipped
TI5010-0165	TI5010-3114	TI5010-0166	TI5010-0167	TI5010-0168	TI5910-0167	TI5910-0168	2-edge tipped
TI5010-0170	TI5010-3116	TI5010-0171	TI5010-0172	TI5010-0173	TI5910-0172	TI5910-0173	2-edge tipped
TI5010-0180	TI5010-3122	TI5010-0181	TI5010-0182	TI5010-0183	TI5910-0182	TI5910-0183	2-edge tipped
TI5010-0185	TI5010-3124	TI5010-0186	TI5010-0187	TI5010-0188	TI5910-0187	TI5910-0188	2-edge tipped
TI5010-0190	TI5010-3126	TI5010-0191	TI5010-0192	TI5010-0193	TI5910-0192	TI5910-0193	2-edge tipped
TI5010-0195	TI5010-3128	TI5010-0196	TI5010-0197	TI5010-0198	TI5910-0197	TI5910-0198	2-edge tipped
TI5010-2402					TI5910-2602		2-edge tipped
TI5010-2404					TI5910-2604		2-edge tipped
TI5010-2412					TI5910-2612		2-edge tipped
TI5010-2414					TI5910-2614		2-edge tipped
					TI5910-0207	TI5910-0208	2-edge tipped
TI5010-0210	TI5010-3144	TI5010-0211	TI5010-0212	TI5010-0213	TI5910-0212	TI5910-0213	2-edge tipped
TI5010-0215	TI5010-3146	TI5010-0216	TI5010-0217	TI5010-0218	TI5910-0217	TI5910-0218	2-edge tipped
TI5010-0225	TI5010-3154	TI5010-0226	TI5010-0227	TI5010-0228	TI5910-0227	TI5910-0228	2-edge tipped
TI5010-0230	TI5010-3156	TI5010-0231	TI5010-0232	TI5010-0233	TI5910-0232	TI5910-0233	2-edge tipped
TI5010-0235	TI5010-3158	TI5010-0236	TI5010-0237	TI5010-0238	TI5910-0237	TI5910-0238	2-edge tipped

Special tools on request for you!  
Please send inquiries to [info@diamond-toolingsystems.com](mailto:info@diamond-toolingsystems.com)

All our products are also available in the online shop.  
Visit us at [diamond-tools24.com](http://diamond-tools24.com)

You can find our complete holder program in our tool holder catalog or in our online shop.

Subject to technical changes.

# CDGW

FullFace | edge tipped

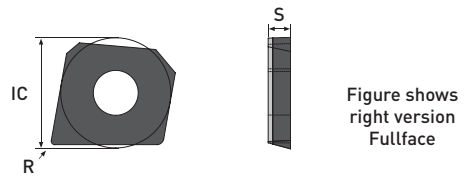
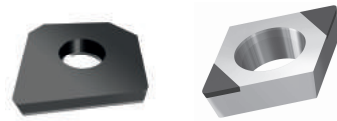

	ISO Code	IC	S	R	P25	P45	K65	K85	S85
					Item No.	Item No.	Item No.	Item No.	Item No.
MiniTools	CDGW 03X101-Rechts	3,20	0,63	0,10			TI5530-0500		
	CDGW 03X102-Rechts	3,20	0,63	0,20			TI5530-0502		
	CDGW 03X101-Links	3,20	0,63	0,10			TI5530-0501		
	CDGW 03X102-Links	3,20	0,63	0,20			TI5530-0503		

! You will find the matching MiniTool holder in our boring bar catalog (03) on page (03).

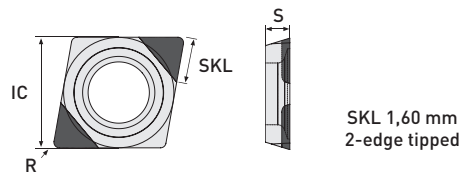

	ISO Code	IC	S	R	P25	P45	K65	K85	S85
					Item No.	Item No.	Item No.	Item No.	Item No.
MiniTools	CDGW 040101	3,97	1,00	0,10			TI5510-2510		
	CDGW 040102	3,97	1,00	0,20			TI5510-2512		
	CDGW 040104	3,97	1,00	0,40			TI5510-2514		

! You will find the matching MiniTool holder in our boring bar catalog (03) on page (03).

### Application range:

- CBN-P Sintered Steel ...
- CBN-K Grey Cast Iron (GCI), Ductile Cast Iron (DCI) ...
- CBN-S Ni-, Co-, Fe- and Cr-Alloys, Titanium, Titanium Alloys ...
- CBN-H Steel hardened up to 72 HRC, Cast Iron hardened ...
- CBN-X Tool Steel hardened, Stellite, Stainless Steel hardened, powder metallurgical Steel ...

You will find further application ranges in the detailed overview on page 8.

i Detailed informations about cutting parameters and cooling can be found on page 56.

- continuous cut
- light interrupted cut
- heavy interrupted cut

Allrounder - hardened Steels							Version
H25	H35	H45	H65	H85	X90	X95	
	2. Alternative	1. Alternative	1. Choice				
Item No.	Item No.	Item No.	Item No.	Item No.	Item No.	Item No.	Item No.
			TI5030-0500		TI5930-0500		FullFace (Z1)
			TI5030-0502		TI5930-0502		FullFace (Z1)
			TI5030-0501		TI5930-0501		FullFace (Z1)
			TI5030-0503		TI5930-0503		FullFace (Z1)

Allrounder - hardened Steels							Version
H25	H35	H45	H65	H85	X90	X95	
	2. Alternative	1. Alternative	1. Choice				
Item No.	Item No.	Item No.	Item No.	Item No.	Item No.	Item No.	Item No.
			TI5010-1511		TI5910-2510		2-edge tipped
			TI5010-1512		TI5910-2512		2-edge tipped
			TI5010-1513		TI5910-2514		2-edge tipped

Special tools on request for you! Please send inquiries to [info@diamond-toolingsystems.com](mailto:info@diamond-toolingsystems.com)

All our products are also available in the online shop. Visit us at [diamond-tools24.com](http://diamond-tools24.com)

You can find our complete holder program in our tool holder catalog or in our online shop.

Subject to technical changes.



# CNGA

edge tipped

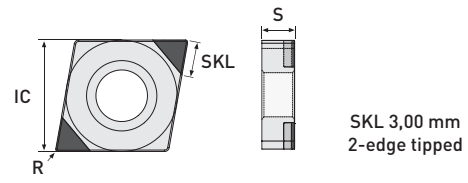

SKL 3,00 mm  
2-edge tipped

	ISO Code	IC	S	R	P25	P45	K65	K85	S85
					Item No.	Item No.	Item No.	Item No.	Item No.
Standard	CNGA 120402	12,70	4,76	0,20	TI5510-0245	TI5510-0246	TI5510-0247	TI5510-0248	TI5510-3202
	CNGA 120404	12,70	4,76	0,40	TI5510-0250	TI5510-0251	TI5510-0252	TI5510-0253	TI5510-3204
	CNGA 120408	12,70	4,76	0,80	TI5510-0255	TI5510-0256	TI5510-0257	TI5510-0258	TI5510-3206
	CNGA 120412	12,70	4,76	1,20	TI5510-0260	TI5510-0261	TI5510-0262	TI5510-0263	TI5510-3208
Wiper	CNGA 120402 R/L-W	12,70	4,76	0,20	TI5510-0270	TI5510-0271	TI5510-0272	TI5510-0273	TI5510-3222
	CNGA 120404 R/L-W	12,70	4,76	0,40	TI5510-0275	TI5510-0276	TI5510-0277	TI5510-0278	TI5510-3224
	CNGA 120408 R/L-W	12,70	4,76	0,80	TI5510-0280	TI5510-0281	TI5510-0282	TI5510-0283	TI5510-3226
	CNGA 120412 R/L-W	12,70	4,76	1,20	TI5510-0285	TI5510-0286	TI5510-0287	TI5510-0288	TI5510-3228

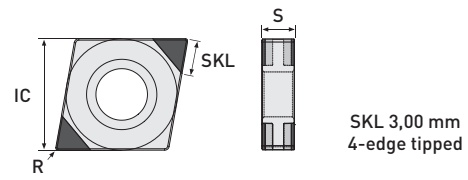

SKL 3,00 mm  
4-edge tipped

	ISO Code	IC	S	R	P25	P45	K65	K85	S85
					Item No.	Item No.	Item No.	Item No.	Item No.
Standard	CNGA 120402	12,70	4,76	0,20	TI5510-0295	TI5510-0296	TI5510-0297	TI5510-0298	
	CNGA 120404	12,70	4,76	0,40	TI5510-0300	TI5510-0301	TI5510-0302	TI5510-0303	
	CNGA 120408	12,70	4,76	0,80	TI5510-0305	TI5510-0306	TI5510-0307	TI5510-0308	
	CNGA 120412	12,70	4,76	1,20	TI5510-0310	TI5510-0311	TI5510-0312	TI5510-0313	
Wiper	CNGA 120402 R/L-W	12,70	4,76	0,20	TI5510-0320	TI5510-0321	TI5510-0322	TI5910-0323	
	CNGA 120404 R/L-W	12,70	4,76	0,40	TI5510-0325	TI5510-0326	TI5510-0327	TI5510-0328	
	CNGA 120408 R/L-W	12,70	4,76	0,80	TI5510-0330	TI5510-0331	TI5510-0332	TI5510-0333	
	CNGA 120412 R/L-W	12,70	4,76	1,20	TI5510-0335	TI5510-0336	TI5510-0337	TI5510-0338	

### Application range:

- CBN-P Sintered Steel ...
- CBN-K Grey Cast Iron (GCI), Ductile Cast Iron (DCI) ...
- CBN-S Ni-, Co-, Fe- and Cr-Alloys, Titanium, Titanium Alloys ...
- CBN-H Steel hardened up to 72 HRC, Cast Iron hardened ...
- CBN-X Tool Steel hardened, Stellite, Stainless Steel hardened, powder metallurgical Steel ...

You will find further application ranges in the detailed overview on page 8.

Detailed informations about cutting parameters and cooling can be found on page 56.

- continuous cut
- light interrupted cut
- heavy interrupted cut

Allrounder - hardened Steels							Version
H25	H35	H45	H65	H85	X90	X95	
	2. Alternative	1. Alternative	1. Choice				
Item No.	Item No.	Item No.	Item No.	Item No.	Item No.	Item No.	Item No.
TI5010-0245	TI5010-3202	TI5010-0246	TI5010-0247	TI5010-0248	TI5910-0247	TI5910-0248	2-edge tipped
TI5010-0250	TI5010-3204	TI5010-0251	TI5010-0252	TI5010-0253	TI5910-0252	TI5910-0253	2-edge tipped
TI5010-0255	TI5010-3206	TI5010-0256	TI5010-0257	TI5010-0258	TI5910-0257	TI5910-0258	2-edge tipped
TI5010-0260	TI5010-3208	TI5010-0261	TI5010-0262	TI5010-0263	TI5910-0262	TI5910-0263	2-edge tipped
TI5010-0270	TI5010-3222	TI5010-0271	TI5010-0272	TI5010-0273	TI5910-0272	TI5910-0273	2-edge tipped
TI5010-0275	TI5010-3224	TI5010-0276	TI5010-0277	TI5010-0278	TI5910-0277	TI5910-0278	2-edge tipped
TI5010-0280	TI5010-3226	TI5010-0281	TI5010-0282	TI5010-0283	TI5910-0282	TI5910-0283	2-edge tipped
TI5010-0285	TI5010-3228	TI5010-0286	TI5010-0287	TI5010-0288	TI5910-0287	TI5910-0288	2-edge tipped

Allrounder - hardened Steels							Version
H25	H35	H45	H65	H85	X90	X95	
	2. Alternative	1. Alternative	1. Choice				
Item No.	Item No.	Item No.	Item No.	Item No.	Item No.	Item No.	Item No.
TI5010-0295		TI5010-0296	TI5010-0297	TI5010-0298	TI5910-0297	TI5910-0298	4-edge tipped
TI5010-0300		TI5010-0301	TI5010-0302	TI5010-0303	TI5910-0302	TI5910-0303	4-edge tipped
TI5010-0305		TI5010-0306	TI5010-0307	TI5010-0308	TI5910-0307	TI5910-0308	4-edge tipped
TI5010-0310		TI5010-0311	TI5010-0312	TI5010-0313	TI5910-0312	TI5910-0313	4-edge tipped
TI5010-0320		TI5010-0321	TI5010-0322	TI5010-0323	TI5910-0322	TI5910-0323	4-edge tipped
TI5010-0325		TI5010-0326	TI5010-0327	TI5010-0328	TI5910-0327	TI5910-0328	4-edge tipped
TI5010-0330		TI5010-0331	TI5010-0332	TI5010-0333	TI5910-0332	TI5910-0333	4-edge tipped
TI5010-0335		TI5010-0336	TI5010-0337	TI5010-0338	TI5910-0337	TI5910-0338	4-edge tipped

Special tools on request for you!  
Please send inquiries to [info@diamond-toolingsystems.com](mailto:info@diamond-toolingsystems.com)

All our products are also available in the online shop.  
Visit us at [diamond-tools24.com](http://diamond-tools24.com)

You can find our complete holder program in our tool holder catalog or in our online shop.

Subject to technical changes.

# DCGW

edge tipped

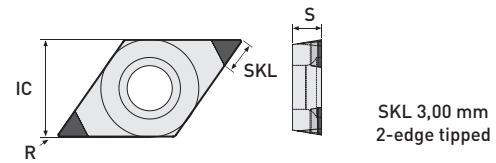
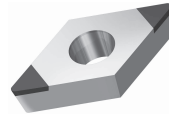

SKL 3,00 mm  
2-edge tipped

	ISO Code	IC	S	R	P25	P45	K65	K85	S85
					Item No.	Item No.	Item No.	Item No.	Item No.
MiniTools	DCGW 04T001 (SKL 2,00)	3,10	1,20	0,10			TI5510-2522		
	DCGW 04T002 (SKL 2,00)	3,10	1,20	0,20			TI5510-2524		
	DCGW 04T004 (SKL 2,00)	3,10	1,20	0,40			TI5510-2526		
Standard	DCGW 070201	6,35	2,38	0,10			TI5510-1224		
	DCGW 070202	6,35	2,38	0,20	TI5510-0385	TI5510-0386	TI5510-0387	TI5510-0388	TI5510-3302
	DCGW 070204	6,35	2,38	0,40	TI5510-0390	TI5510-0391	TI5510-0392	TI5510-0393	TI5510-3304
	DCGW 070208	6,35	2,38	0,80	TI5510-0395	TI5510-0396	TI5510-0397	TI5510-0398	TI5510-3306
	DCGW 11T301	9,525	3,97	0,10			TI5510-1225		
	DCGW 11T302	9,525	3,97	0,20	TI5510-0405	TI5510-0406	TI5510-0407	TI5510-0408	TI5510-3322
	DCGW 11T304	9,525	3,97	0,40	TI5510-0410	TI5510-0411	TI5510-0412	TI5510-0413	TI5510-3324
	DCGW 11T308	9,525	3,97	0,80	TI5510-0415	TI5510-0416	TI5510-0417	TI5510-0418	TI5510-3326
Scharf	DCGW 070202-F	6,35	2,38	0,20			TI5510-2632		
	DCGW 070204-F	6,35	2,38	0,40			TI5510-2634		
	DCGW 11T302-F	9,525	3,97	0,20			TI5510-2642		
	DCGW 11T304-F	9,525	3,97	0,40			TI5510-2644		
Wiper	DCGW 070204 R/L-W	6,35	2,38	0,40	TI5510-0425	TI5510-0426	TI5510-0427	TI5510-0428	TI5510-3344
	DCGW 070208 R/L-W	6,35	2,38	0,80	TI5510-0430	TI5510-0431	TI5510-0432	TI5510-0433	TI5510-3446
	DCGW 11T304 R/L-W	9,525	3,97	0,40	TI5510-0440	TI5510-0441	TI5510-0442	TI5510-0443	TI5510-3364
	DCGW 11T308 R/L-W	9,525	3,97	0,80	TI5510-0445	TI5510-0446	TI5510-0447	TI5510-0448	TI5510-3366

! You can find the matching MiniTool holders for plate size 04 in our precision boring tools catalogue (03).

### Application range:

- CBN-P Sintered Steel ...
- CBN-K Grey Cast Iron (GCI), Ductile Cast Iron (DCI) ...
- CBN-S Ni-, Co-, Fe- and Cr-Alloys, Titanium, Titanium Alloys ...
- CBN-H Steel hardened up to 72 HRC, Cast Iron hardened ...
- CBN-X Tool Steel hardened, Stellite, Stainless Steel hardened, powder metallurgical Steel ...

You will find further application ranges in the detailed overview on page 8.

**i** Detailed informations about cutting parameters and cooling can be found on page 56.

- continuous cut
- light interrupted cut
- heavy interrupted cut

Allrounder - hardened Steels							Version
H25	H35	H45	H65	H85	X90	X95	
	2. Alternative	1. Alternative	1. Choice				
Item No.	Item No.	Item No.	Item No.	Item No.	Item No.	Item No.	Item No.
			TI5010-1521		TI5910-2522		2-edge tipped
			TI5010-1522		TI5910-2524		2-edge tipped
			TI5010-1523		TI5910-2526		2-edge tipped
TI5010-1224					TI5910-1224		2-edge tipped
TI5010-0385	TI5010-3302	TI5010-0386	TI5010-0387	TI5010-0388	TI5910-0387	TI5910-0388	2-edge tipped
TI5010-0390	TI5010-3304	TI5010-0391	TI5010-0392	TI5010-0393	TI5910-0392	TI5910-0393	2-edge tipped
TI5010-0395	TI5010-3306	TI5010-0396	TI5010-0397	TI5010-0398	TI5910-0397	TI5910-0398	2-edge tipped
TI5010-1225					TI5910-1225		2-edge tipped
TI5010-0405	TI5010-3322	TI5010-0406	TI5010-0407	TI5010-0408	TI5910-0407	TI5910-0408	2-edge tipped
TI5010-0410	TI5010-3324	TI5010-0411	TI5010-0412	TI5010-0413	TI5910-0412	TI5910-0413	2-edge tipped
TI5010-0415	TI5010-3326	TI5010-0416	TI5010-0417	TI5010-0418	TI5910-0417	TI5910-0418	2-edge tipped
TI5010-2432					TI5910-2632		2-edge tipped
TI5010-2434					TI5910-2634		2-edge tipped
TI5010-2442					TI5910-2642		2-edge tipped
TI5010-2444					TI5910-2644		2-edge tipped
TI5010-0425	TI5010-3344	TI5010-0426	TI5010-0427	TI5010-0428	TI5910-0427	TI5910-0428	2-edge tipped
TI5010-0430	TI5010-3346	TI5010-0431	TI5010-0432	TI5010-0433	TI5910-0432	TI5910-0433	2-edge tipped
TI5010-0440	TI5010-3364	TI5010-0441	TI5010-0442	TI5010-0443	TI5910-0442	TI5910-0443	2-edge tipped
TI5010-0445	TI5010-3366	TI5010-0446	TI5010-0447	TI5010-0448	TI5910-0447	TI5910-0448	2-edge tipped

Special tools on request for you!  
Please send inquiries to [info@diamond-toolingsystems.com](mailto:info@diamond-toolingsystems.com)

All our products are also available in the online shop.  
Visit us at [diamond-tools24.com](http://diamond-tools24.com)

You can find our complete holder program in our tool holder catalog or in our online shop.

Subject to technical changes.

# DNGA

edge tipped

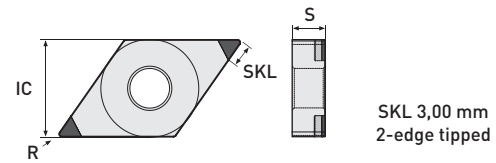
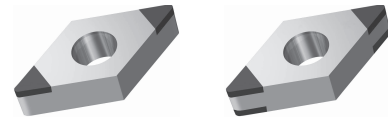

				P25	P45	K65	K85	S85
ISO Code	IC	S	R	Item No.	Item No.	Item No.	Item No.	Item No.
<b>DNGA 150401</b>	12,70	4,76	0,10			TI5510-0472		
<b>DNGA 150402</b>	12,70	4,76	0,20	TI5510-0475	TI5510-0476	TI5510-0477	TI5510-0478	TI5510-3402
<b>DNGA 150404</b>	12,70	4,76	0,40	TI5510-0480	TI5510-0481	TI5510-0482	TI5510-0483	TI5510-3404
<b>DNGA 150408</b>	12,70	4,76	0,80	TI5510-0485	TI5510-0486	TI5510-0487	TI5510-0488	TI5510-3406
<b>DNGA 150412</b>	12,70	4,76	1,20	TI5510-0490	TI5510-0491	TI5510-0492	TI5510-0493	TI5510-3408
<b>DNGA 150404 R/L-W</b>	12,70	4,76	0,40	TI5510-0525	TI5510-0526	TI5510-0527	TI5510-0528	TI5510-3444
<b>DNGA 150408 R/L-W</b>	12,70	4,76	0,80	TI5510-0530	TI5510-0531	TI5510-0532	TI5510-0533	TI5510-3446

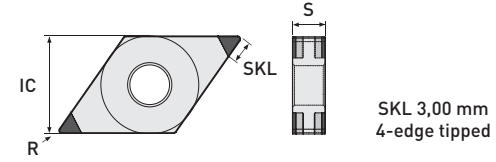

				P25	P45	K65	K85	S85
ISO Code	IC	S	R	Item No.	Item No.	Item No.	Item No.	Item No.
<b>DNGA 150402</b>	12,70	4,76	0,20	TI5510-0570	TI5510-0571	TI5510-0572	TI5510-0573	
<b>DNGA 150404</b>	12,70	4,76	0,40	TI5510-0575	TI5510-0576	TI5510-0577	TI5510-0578	
<b>DNGA 150408</b>	12,70	4,76	0,80	TI5510-0580	TI5510-0581	TI5510-0582	TI5510-0583	
<b>DNGA 150412</b>	12,70	4,76	1,20	TI5510-0585	TI5510-0586	TI5510-0587	TI5510-0588	
<b>DNGA 150404 R/L-W</b>	12,70	4,76	0,40	TI5510-0620	TI5510-0621	TI5510-0622	TI5510-0623	
<b>DNGA 150408 R/L-W</b>	12,70	4,76	0,80	TI5510-0625	TI5510-0626	TI5510-0627	TI5510-0628	

### Application range:

- CBN-P Sintered Steel ...
- CBN-K Grey Cast Iron (GCI), Ductile Cast Iron (DCI) ...
- CBN-S Ni-, Co-, Fe- and Cr-Alloys, Titanium, Titanium Alloys ...
- CBN-H Steel hardened up to 72 HRC, Cast Iron hardened ...
- CBN-X Tool Steel hardened, Stellite, Stainless Steel hardened, powder metallurgical Steel ...

You will find further application ranges in the detailed overview on page 8.

Detailed informations about cutting parameters and cooling can be found on page 56.

- continuous cut
- light interrupted cut
- heavy interrupted cut

### Allrounder - hardened Steels

H25	H35	H45	H65	H85	X90	X95	
	2. Alternative	1. Alternative	1. Choice				
Item No.	Item No.	Item No.	Item No.	Item No.	Item No.	Item No.	Version
TI5010-0470					TI5910-0472		2-edge tipped
TI5010-0475	TI5010-3402	TI5010-0476	TI5010-0477	TI5010-0478	TI5910-0477	TI5910-0478	2-edge tipped
TI5010-0480	TI5010-3404	TI5010-0481	TI5010-0482	TI5010-0483	TI5910-0482	TI5910-0483	2-edge tipped
TI5010-0485	TI5010-3406	TI5010-0486	TI5010-0487	TI5010-0488	TI5910-0487	TI5910-0488	2-edge tipped
TI5010-0490	TI5010-3408	TI5010-0491	TI5010-0492	TI5010-0493	TI5910-0492	TI5910-0493	2-edge tipped
TI5010-0525	TI5010-3444	TI5010-0526	TI5010-0527	TI5010-0528	TI5910-0527	TI5910-0528	2-edge tipped
TI5010-0530	TI5010-3446	TI5010-0531	TI5010-0532	TI5010-0533	TI5910-0532	TI5910-0533	2-edge tipped

### Allrounder - hardened Steels

H25	H35	H45	H65	H85	X90	X95	
	2. Alternative	1. Alternative	1. Choice				
Item No.	Item No.	Item No.	Item No.	Item No.	Item No.	Item No.	Version
TI5010-0570		TI5010-0571	TI5010-0572	TI5010-0573	TI5910-0572	TI5910-0573	4-edge tipped
TI5010-0575		TI5010-0576	TI5010-0577	TI5010-0578	TI5910-0577	TI5910-0578	4-edge tipped
TI5010-0580		TI5010-0581	TI5010-0582	TI5010-0583	TI5910-0582	TI5910-0583	4-edge tipped
TI5010-0585		TI5010-0586	TI5010-0587	TI5010-0588	TI5910-0587	TI5910-0588	4-edge tipped
TI5010-0620		TI5010-0621	TI5010-0622	TI5010-0623	TI5910-0622	TI5910-0623	4-edge tipped
TI5010-0625		TI5010-0626	TI5010-0627	TI5010-0628	TI5910-0627	TI5910-0628	4-edge tipped

Special tools on request for you!  
Please send inquiries to [info@diamond-toolingsystems.com](mailto:info@diamond-toolingsystems.com)

All our products are also available in the online shop.  
Visit us at [diamond-tools24.com](http://diamond-tools24.com)

You can find our complete holder program in our tool holder catalog or in our online shop.

Subject to technical changes.

# DNGA

edge tipped

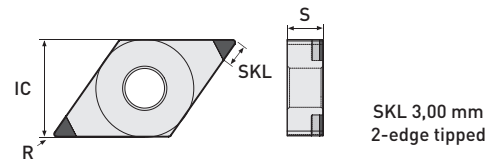
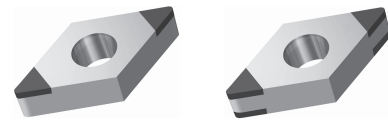

		P25	P45	K65	K85	S85			
ISO Code	IC	S	R	Item No.	Item No.	Item No.	Item No.	Item No.	
<b>Standard</b>	DNGA 150601	12,70	6,35	0,10			TI5510-0497		
	DNGA 150602	12,70	6,35	0,20	TI5510-0500	TI5510-0501	TI5510-0502	TI5510-0503	TI5510-3422
	DNGA 150604	12,70	6,35	0,40	TI5510-0505	TI5510-0506	TI5510-0507	TI5510-0508	TI5510-3424
	DNGA 150608	12,70	6,35	0,80	TI5510-0510	TI5510-0511	TI5510-0512	TI5510-0513	TI5510-3426
	DNGA 150612	12,70	6,35	1,20	TI5510-0515	TI5510-0516	TI5510-0517	TI5510-0518	TI5510-3428
<b>Wiper</b>	DNGA 150604 R/L-W	12,70	6,35	0,40	TI5510-0535	TI5510-0536	TI5510-0537	TI5510-0538	TI5510-3464
	DNGA 150608 R/L-W	12,70	6,35	0,80	TI5510-0540	TI5510-0541	TI5510-0542	TI5510-0543	TI5510-3466

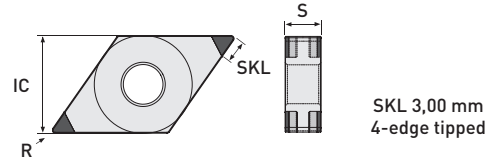

		P25	P45	K65	K85	S85		
ISO Code	IC	S	R	Item No.	Item No.	Item No.	Item No.	Item No.
<b>Standard</b>	DNGA 150602	12,70	6,35	0,20	TI5510-0595	TI5510-0596	TI5510-0597	TI5510-0598
	DNGA 150604	12,70	6,35	0,40	TI5510-0600	TI5510-0601	TI5510-0602	TI5510-0603
	DNGA 150608	12,70	6,35	0,80	TI5510-0605	TI5510-0606	TI5510-0607	TI5510-0608
	DNGA 150612	12,70	6,35	1,20	TI5510-0610	TI5510-0611	TI5510-0612	TI5510-0613
<b>Wiper</b>	DNGA 150604 R/L-W	12,70	6,35	0,40	TI5510-0630	TI5510-0631	TI5510-0632	TI5510-0633
	DNGA 150608 R/L-W	12,70	6,35	0,80	TI5510-0635	TI5510-0636	TI5510-0637	TI5510-0638

### Application range:

- CBN-P Sintered Steel ...
- CBN-K Grey Cast Iron (GCI), Ductile Cast Iron (DCI) ...
- CBN-S Ni-, Co-, Fe- and Cr-Alloys, Titanium, Titanium Alloys ...
- CBN-H Steel hardened up to 72 HRC, Cast Iron hardened ...
- CBN-X Tool Steel hardened, Stellite, Stainless Steel hardened, powder metallurgical Steel ...

You will find further application ranges in the detailed overview on page 8.

Detailed informations about cutting parameters and cooling can be found on page 56.

- continuous cut
- light interrupted cut
- heavy interrupted cut

Allrounder - hardened Steels							Version
H25	H35	H45	H65	H85	X90	X95	
	2. Alternative	1. Alternative	1. Choice				
Item No.	Item No.	Item No.	Item No.	Item No.	Item No.	Item No.	Version
TI5010-0495					TI5910-0497		2-edge tipped
TI5010-0500	TI5010-3422	TI5010-0501	TI5010-0502	TI5010-0503	TI5910-0502	TI5910-0503	2-edge tipped
TI5010-0505	TI5010-3424	TI5010-0506	TI5010-0507	TI5010-0508	TI5910-0507	TI5910-0508	2-edge tipped
TI5010-0510	TI5010-3426	TI5010-0511	TI5010-0512	TI5010-0513	TI5910-0512	TI5910-0513	2-edge tipped
TI5010-0515	TI5010-3428	TI5010-0516	TI5010-0517	TI5010-0518	TI5910-0517	TI5910-0518	2-edge tipped
TI5010-0535	TI5010-3464	TI5010-0536	TI5010-0537	TI5010-0538	TI5910-0537	TI5910-0538	2-edge tipped
TI5010-0540	TI5010-3466	TI5010-0541	TI5010-0542	TI5010-0543	TI5910-0542	TI5910-0543	2-edge tipped

Allrounder - hardened Steels							Version
H25	H35	H45	H65	H85	X90	X95	
	2. Alternative	1. Alternative	1. Choice				
Item No.	Item No.	Item No.	Item No.	Item No.	Item No.	Item No.	Version
TI5010-0595		TI5010-0596	TI5010-0597	TI5010-0598	TI5910-0597	TI5910-0598	4-edge tipped
TI5010-0600		TI5010-0601	TI5010-0602	TI5010-0603	TI5910-0602	TI5910-0603	4-edge tipped
TI5010-0605		TI5010-0606	TI5010-0607	TI5010-0608	TI5910-0607	TI5910-0608	4-edge tipped
TI5010-0610		TI5010-0611	TI5010-0612	TI5010-0613	TI5910-0612	TI5910-0613	4-edge tipped
TI5010-0630		TI5010-0631	TI5010-0632	TI5010-0633	TI5910-0632	TI5910-0633	4-edge tipped
TI5010-0635		TI5010-0636	TI5010-0637	TI5010-0638	TI5910-0637	TI5910-0638	4-edge tipped

Special tools on request for you! Please send inquiries to [info@diamond-toolingsystems.com](mailto:info@diamond-toolingsystems.com)

All our products are also available in the online shop. Visit us at [diamond-tools24.com](http://diamond-tools24.com)

You can find our complete holder program in our tool holder catalog or in our online shop.

Subject to technical changes.

# EPGW

edge tipped | FullFace

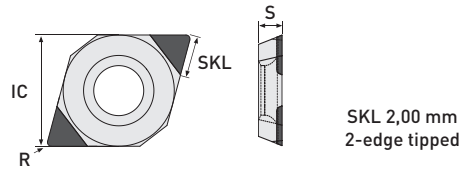
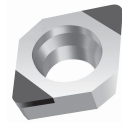

SKL 2,00 mm  
2-edge tipped

ISO Code	IC	S	R	P25	P45	K65	K85	S85
				Item No.	Item No.	Item No.	Item No.	Item No.
EPGW 050201	5,56	2,38	0,10			TI5510-2550		
EPGW 050202	5,56	2,38	0,20			TI5510-2552		
EPGW 050204	5,56	2,38	0,40			TI5510-2554		

MiniTools

**i** Detailed informations about cutting parameters and cooling can be found on page 56.

- continuous cut
- light interrupted cut
- heavy interrupted cut

Allrounder - hardened Steels							Version
H25	H35	H45	H65	H85	X90	X95	
	2. Alternative	1. Alternative	1. Choice				
Item No.	Item No.	Item No.	Item No.	Item No.	Item No.	Item No.	Item No.
			TI5010-1531		TI5910-2550		2-edge tipped
			TI5010-1532		TI5910-2552		2-edge tipped
			TI5010-1533		TI5910-2554		2-edge tipped

**i** You will find the matching MiniTool holder in our boring bar catalog [03] on page [03].

### Application range:

- CBN-P Sintered Steel ...
- CBN-K Grey Cast Iron (GCI), Ductile Cast Iron (DCI) ...
- CBN-S Ni-, Co-, Fe- and Cr-Alloys, Titanium, Titanium Alloys ...
- CBN-H Steel hardened up to 72 HRC, Cast Iron hardened ...
- CBN-X Tool Steel hardened, Stellite, Stainless Steel hardened, powder metallurgical Steel ...

You will find further application ranges in the detailed overview on page 8.

Special tools on request for you!  
Please send inquiries to [info@diamond-toolingsystems.com](mailto:info@diamond-toolingsystems.com)

All our products are also available in the online shop.  
Visit us at [diamond-tools24.com](http://diamond-tools24.com)

You can find our complete holder program in our tool holder catalog or in our online shop.

Subject to technical changes.



# RBGN | RCGW

FullFace

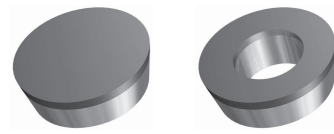

**i** Detailed informations about cutting parameters and cooling can be found on page 56.

- continuous cut
- light interrupted cut
- heavy interrupted cut

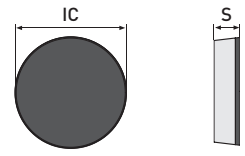

FullFace

				P25	P45	K65	K85	S85
ISO Code	IC	S	R	Item No.	Item No.	Item No.	Item No.	Item No.
RBGN 0602M0	6,00	2,38	-			TI5530-0090		
RBGN 0803M0	8,00	3,18	-			TI5530-0092		
RBGN 1003M0	10,00	3,18	-			TI5530-0094		
RBGN 1203M0	12,00	3,18	-			TI5530-0096		

## Allrounder - hardened Steels

H25	H35	H45	H65	H85	X90	X95	
	2. Alternative	1. Alternative	1. Choice				
Item No.	Item No.	Item No.	Item No.	Item No.	Item No.	Item No.	Version
			TI5030-0090		TI5930-0090		FullFace
			TI5030-0092		TI5930-0092		FullFace
			TI5030-0094		TI5930-0094		FullFace
			TI5030-0096		TI5930-0096		FullFace

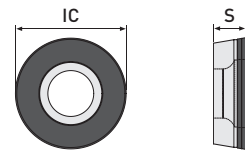

FullFace

				P25	P45	K65	K85	S85
ISO Code	IC	S	R	Item No.	Item No.	Item No.	Item No.	Item No.
RCGW 0602M0	6,00	2,38	-			TI5530-0102		
RCGW 0803M0	8,00	3,18	-			TI5530-0107		
RCGW 1003M0	10,00	3,18	-			TI5530-0117		
RCGW 10T3M0	10,00	3,97	-			TI5530-0122		
RCGW 1204M0	12,00	4,76	-			TI5530-0127		

## Allrounder - hardened Steels

H25	H35	H45	H65	H85	X90	X95	
	2. Alternative	1. Alternative	1. Choice				
Item No.	Item No.	Item No.	Item No.	Item No.	Item No.	Item No.	Version
			TI5030-0100		TI5930-0102		FullFace
			TI5030-0105		TI5930-0107		FullFace
			TI5030-0115		TI5930-0117		FullFace
			TI5030-0120		TI5930-0122		FullFace
			TI5030-0125		TI5930-0127		FullFace

**i** You can find the matching MiniTool holders for plate size 06 in our precision boring tools catalogue [03].

### Application range:

- CBN-P Sintered Steel ...
- CBN-K Grey Cast Iron (GCI), Ductile Cast Iron (DCI) ...
- CBN-S Ni-, Co-, Fe- and Cr-Alloys, Titanium, Titanium Alloys ...
- CBN-H Steel hardened up to 72 HRC, Cast Iron hardened ...
- CBN-X Tool Steel hardened, Stellite, Stainless Steel hardened, powder metallurgical Steel ...

You will find further application ranges in the detailed overview on page 8.

Special tools on request for you!  
Please send inquiries to [info@diamond-toolingsystems.com](mailto:info@diamond-toolingsystems.com)

All our products are also available in the online shop.  
Visit us at [diamond-tools24.com](http://diamond-tools24.com)

You can find our complete holder program in our tool holder catalog or in our online shop.

Subject to technical changes.

# RNGN

Solid

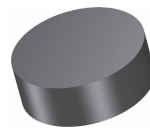

Detailed informations about cutting parameters and cooling can be found on page 56.

- continuous cut
- light interrupted cut
- heavy interrupted cut

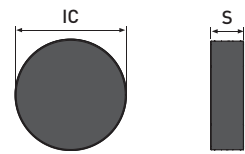

Solid

	P25	P45	K65	K85	S85			
ISO Code	IC	S	R	Item No.	Item No.	Item No.	Item No.	Item No.
RNGN 060300	6,35	3,18	-					TI5540-0090
RNGN 060400	6,35	4,76	-					TI5540-0091
RNGN 090300	9,52	3,18	-					TI5540-0100
RNGN 090400	9,52	4,76	-					TI5540-0105
RNGN 120300	12,70	3,18	-					TI5540-0115
RNGN 120400	12,70	4,76	-					TI5540-0120

## Allrounder - hardened Steels

H25	H35	H45	H65	H85	X90	X95	Version
	2. Alternative	1. Alternative	1. Choice				
Item No.	Item No.	Item No.	Item No.	Item No.	Item No.	Item No.	Item No.
			TI5040-0090		TI5940-0090		Solid
			TI5040-0091		TI5940-0091		Solid
			TI5040-0100		TI5940-0100		Solid
			TI5040-0105		TI5940-0105		Solid
			TI5040-0115		TI5940-0115		Solid
			TI5040-0120		TI5940-0120		Solid

Standard

### Application range:

- CBN-P Sintered Steel ...
- CBN-K Grey Cast Iron (GCI), Ductile Cast Iron (DCI) ...
- CBN-S Ni-, Co-, Fe- and Cr-Alloys, Titanium, Titanium Alloys ...
- CBN-H Steel hardened up to 72 HRC, Cast Iron hardened ...
- CBN-X Tool Steel hardened, Stellite, Stainless Steel hardened, powder metallurgical Steel ...

You will find further application ranges in the detailed overview on page 8.

Special tools on request for you!  
Please send inquiries to [info@diamond-toolingsystems.com](mailto:info@diamond-toolingsystems.com)

All our products are also available in the online shop.  
Visit us at [diamond-tools24.com](http://diamond-tools24.com)

You can find our complete **holder program** in our tool holder catalog or in our online shop.

Subject to technical changes.

# SCGW

edge tipped

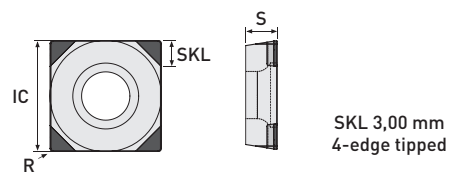
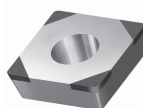

	ISO Code	IC	S	R	P25	P45	K65	K85	S85
					Item No.	Item No.	Item No.	Item No.	Item No.
Standard	SCGW 09T302	9,525	3,97	0,20	TI5510-0645	TI5510-0646	TI5510-0647	TI5510-0648	
	SCGW 09T304	9,525	3,97	0,40	TI5510-0650	TI5510-0651	TI5510-0652	TI5510-0653	
	SCGW 09T308	9,525	3,97	0,80	TI5510-0655	TI5510-0656	TI5510-0657	TI5510-0658	
	SCGW 120402	12,70	4,76	0,20	TI5510-0665	TI5510-0666	TI5010-0667	TI5510-0668	
	SCGW 120404	12,70	4,76	0,40	TI5510-0670	TI5510-0671	TI5510-0672	TI5510-0673	
	SCGW 120408	12,70	4,76	0,80	TI5510-0675	TI5510-0676	TI5510-0677	TI5510-0678	
	SCGW 120412	12,70	4,76	1,20	TI5510-0680	TI5510-0681	TI5510-0682	TI5510-0683	

**i** Detailed informations about cutting parameters and cooling can be found on page 56.

- continuous cut
- light interrupted cut
- heavy interrupted cut

Allrounder - hardened Steels							Version
H25	H35	H45	H65	H85	X90	X95	
	2. Alternative	1. Alternative	1. Choice				
Item No.	Item No.	Item No.	Item No.	Item No.	Item No.	Item No.	Item No.
TI5010-0645		TI5010-0646	TI5010-0647	TI5010-0648	TI5910-0647	TI5910-0648	4-edge tipped
TI5010-0650		TI5010-0651	TI5010-0652	TI5010-0653	TI5910-0652	TI5910-0653	4-edge tipped
TI5010-0655		TI5010-0656	TI5010-0657	TI5010-0658	TI5910-0657	TI5910-0658	4-edge tipped
TI5010-0665		TI5010-0666	TI5010-0667	TI5010-0668	TI5910-0667	TI5910-0668	4-edge tipped
TI5010-0670		TI5010-0671	TI5010-0672	TI5010-0673	TI5910-0672	TI5910-0673	4-edge tipped
TI5010-0675		TI5010-0676	TI5010-0677	TI5010-0678	TI5910-0677	TI5910-0678	4-edge tipped
TI5010-0680		TI5010-0681	TI5010-0682	TI5010-0683	TI5910-0682	TI5910-0683	4-edge tipped

### Application range:

- CBN-P Sintered Steel ...
- CBN-K Grey Cast Iron (GCI), Ductile Cast Iron (DCI) ...
- CBN-S Ni-, Co-, Fe- and Cr-Alloys, Titanium, Titanium Alloys ...
- CBN-H Steel hardened up to 72 HRC, Cast Iron hardened ...
- CBN-X Tool Steel hardened, Stellite, Stainless Steel hardened, powder metallurgical Steel ...

You will find further application ranges in the detailed overview on page 8.

Special tools on request for you!  
Please send inquiries to [info@diamond-toolingsystems.com](mailto:info@diamond-toolingsystems.com)

All our products are also available in the online shop.  
Visit us at [diamond-tools24.com](http://diamond-tools24.com)

You can find our complete **holder program** in our tool holder catalog or in our online shop.

Subject to technical changes.

# SNGA

edge tipped

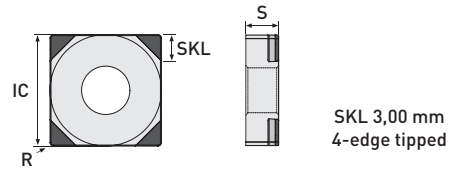
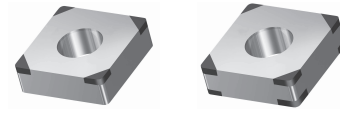

	P25	P45	K65	K85	S85			
ISO Code	IC	S	R	Item No.	Item No.	Item No.	Item No.	Item No.
<b>SNGA 120404</b>	12,70	4,76	0,40	TI5510-0690	TI5510-0691	TI5510-0692	TI5510-0693	
<b>SNGA 120408</b>	12,70	4,76	0,80	TI5510-0695	TI5510-0696	TI5510-0697	TI5510-0698	
<b>SNGA 120412</b>	12,70	4,76	1,20	TI5510-0700	TI5510-0701	TI5510-0702	TI5510-0703	

Standard

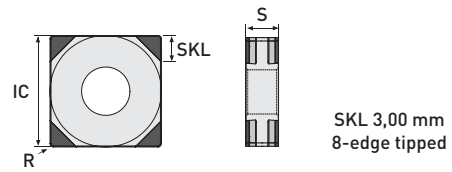

	P25	P45	K65	K85	S85			
ISO Code	IC	S	R	Item No.	Item No.	Item No.	Item No.	Item No.
<b>SNGA 120404</b>	12,70	4,76	0,40	TI5510-0710	TI5510-0711	TI5510-0712	TI5510-0713	
<b>SNGA 120408</b>	12,70	4,76	0,80	TI5510-0715	TI5510-0716	TI5510-0717	TI5510-0718	
<b>SNGA 120412</b>	12,70	4,76	1,20	TI5510-0720	TI5510-0721	TI5510-0722	TI5510-0723	

Standard

### Application range:

- CBN-P Sintered Steel ...
- CBN-K Grey Cast Iron (GCI), Ductile Cast Iron (DCI) ...
- CBN-S Ni-, Co-, Fe- and Cr-Alloys, Titanium, Titanium Alloys ...
- CBN-H Steel hardened up to 72 HRC, Cast Iron hardened ...
- CBN-X Tool Steel hardened, Stellite, Stainless Steel hardened, powder metallurgical Steel ...

You will find further application ranges in the detailed overview on page 8.

Detailed informations about cutting parameters and cooling can be found on page 56.

- continuous cut
- light interrupted cut
- heavy interrupted cut

### Allrounder - hardened Steels

H25	H35	H45	H65	H85	X90	X95	Version
	2. Alternative	1. Alternative	1. Choice				
Item No.	Item No.	Item No.	Item No.	Item No.	Item No.	Item No.	Version
TI5010-0690		TI5010-0691	TI5010-0692	TI5010-0693	TI5910-0692	TI5910-0693	4-edge tipped
TI5010-0695		TI5010-0696	TI5010-0697	TI5010-0698	TI5910-0697	TI5910-0698	4-edge tipped
TI5010-0700		TI5010-0701	TI5010-0702	TI5010-0703	TI5910-0702	TI5910-0703	4-edge tipped

### Allrounder - hardened Steels

H25	H35	H45	H65	H85	X90	X95	Version
	2. Alternative	1. Alternative	1. Choice				
Item No.	Item No.	Item No.	Item No.	Item No.	Item No.	Item No.	Version
TI5010-0710		TI5010-0711	TI5010-0712	TI5010-0713	TI5910-0712	TI5910-0713	8-edge tipped
TI5010-0715		TI5010-0716	TI5010-0717	TI5010-0718	TI5910-0717	TI5910-0718	8-edge tipped
TI5010-0720		TI5010-0721	TI5010-0722	TI5010-0723	TI5910-0722	TI5910-0723	8-edge tipped

Special tools on request for you!  
Please send inquiries to [info@diamond-toolingsystems.com](mailto:info@diamond-toolingsystems.com)

All our products are also available in the online shop.  
Visit us at [diamond-tools24.com](http://diamond-tools24.com)

You can find our complete holder program in our tool holder catalog or in our online shop.

Subject to technical changes.

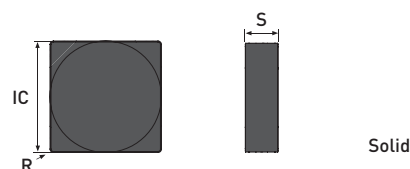
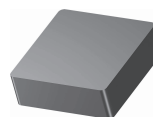

Solid

ISO Code	IC	S	R	P25	P45	K65	K85	S85
				Item No.	Item No.	Item No.	Item No.	Item No.
SNGN 090304	9,525	3,18	0,40			TI5540-0130		
SNGN 090308	9,525	3,18	0,80			TI5540-0135		
SNGN 090312	9,525	3,18	1,20			TI5540-0140		
SNGN 120404	12,70	4,76	0,40			TI5540-0145		
SNGN 120408	12,70	4,76	0,80			TI5540-0150		
SNGN 120412	12,70	4,76	1,20			TI5540-0155		
SNGN 120416	12,70	4,76	1,60			TI5540-0160		

Standard

Detailed informations about cutting parameters and cooling can be found on page 56.

- continuous cut
- light interrupted cut
- heavy interrupted cut

Allrounder - hardened Steels							Version
H25	H35	H45	H65	H85	X90	X95	
	2. Alternative	1. Alternative	1. Choice				
Item No.	Item No.	Item No.	Item No.	Item No.	Item No.	Item No.	Item No.
			TI5040-0130		TI5940-0130		Solid
			TI5040-0135		TI5940-0135		Solid
			TI5040-0140		TI5940-0140		Solid
			TI5040-0145		TI5940-0145		Solid
			TI5040-0150		TI5940-0150		Solid
			TI5040-0155		TI5940-0155		Solid
			TI5040-0160		TI5940-0160		Solid

### Application range:

- CBN-P Sintered Steel ...
- CBN-K Grey Cast Iron (GCI), Ductile Cast Iron (DCI) ...
- CBN-S Ni-, Co-, Fe- and Cr-Alloys, Titanium, Titanium Alloys ...
- CBN-H Steel hardened up to 72 HRC, Cast Iron hardened ...
- CBN-X Tool Steel hardened, Stellite, Stainless Steel hardened, powder metallurgical Steel ...

You will find further application ranges in the detailed overview on page 8.

Special tools on request for you!  
Please send inquiries to [info@diamond-toolingsystems.com](mailto:info@diamond-toolingsystems.com)

All our products are also available in the online shop.  
Visit us at [diamond-tools24.com](http://diamond-tools24.com)

You can find our complete holder program in our tool holder catalog or in our online shop.

Subject to technical changes.



# TCGW

edge tipped

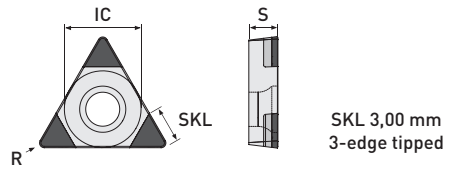
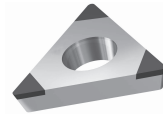

SKL 3,00 mm  
3-edge tipped

ISO Code	IC	S	R	P25	P45	K65	K85	S85
				Item No.	Item No.	Item No.	Item No.	Item No.
TCGW 090201	5,56	2,38	0,10					
TCGW 090202	5,56	2,38	0,20	TI5510-0730	TI5510-0731	TI5510-0732	TI5510-0733	TI5510-3502
TCGW 090204	5,56	2,38	0,40	TI5510-0735	TI5510-0736	TI5510-0737	TI5510-0738	TI5510-3504
TCGW 090208	5,56	2,38	0,80	TI5510-0740	TI5510-0741	TI5510-0742	TI5510-0743	TI5510-3506
TCGW 110201	6,35	2,38	0,10					
TCGW 110202	6,35	2,38	0,20	TI5510-0750	TI5510-0751	TI5510-0752	TI5510-0753	TI5510-3522
TCGW 110204	6,35	2,38	0,40	TI5510-0755	TI5510-0756	TI5510-0757	TI5510-0758	TI5510-3524
TCGW 110208	6,35	2,38	0,80	TI5510-0760	TI5510-0761	TI5510-0762	TI5510-0763	TI5510-3526
TCGW 16T302	9,525	3,97	0,20	TI5510-0770	TI5510-0771	TI5510-0772	TI5510-0773	TI5510-3542
TCGW 16T304	9,525	3,97	0,40	TI5510-0775	TI5510-0776	TI5510-0777	TI5510-0778	TI5510-3544
TCGW 16T308	9,525	3,97	0,80	TI5510-0780	TI5510-0781	TI5510-0782	TI5510-0783	TI5510-3546

Standard

Detailed informations about cutting parameters and cooling can be found on page 56.

- continuous cut
- light interrupted cut
- heavy interrupted cut

Allrounder - hardened Steels							Version
H25	H35	H45	H65	H85	X90	X95	
	2. Alternative	1. Alternative	1. Choice				
Item No.	Item No.	Item No.	Item No.	Item No.	Item No.	Item No.	Version
TI5010-0725							3-edge tipped
TI5010-0730	TI5010-3502	TI5010-0731	TI5010-0732	TI5010-0733	TI5910-0732	TI5910-0733	3-edge tipped
TI5010-0735	TI5010-3504	TI5010-0736	TI5010-0737	TI5010-0738	TI5910-0737	TI5910-0738	3-edge tipped
TI5010-0740	TI5010-3506	TI5010-0741	TI5010-0742	TI5010-0743	TI5910-0742	TI5910-0743	3-edge tipped
TI5010-0745							3-edge tipped
TI5010-0750	TI5010-3522	TI5010-0751	TI5010-0752	TI5010-0753	TI5910-0752	TI5910-0753	3-edge tipped
TI5010-0755	TI5010-3524	TI5010-0756	TI5010-0757	TI5010-0758	TI5910-0757	TI5910-0758	3-edge tipped
TI5010-0760	TI5010-3526	TI5010-0761	TI5010-0762	TI5010-0763	TI5910-0762	TI5910-0763	3-edge tipped
TI5010-0770	TI5010-3542	TI5010-0771	TI5010-0772	TI5010-0773	TI5910-0772	TI5910-0773	3-edge tipped
TI5010-0775	TI5010-3544	TI5010-0776	TI5010-0777	TI5010-0778	TI5910-0777	TI5910-0778	3-edge tipped
TI5010-0780	TI5010-3546	TI5010-0781	TI5010-0782	TI5010-0783	TI5910-0782	TI5910-0783	3-edge tipped

### Application range:

- CBN-P Sintered Steel ...
- CBN-K Grey Cast Iron (GCI), Ductile Cast Iron (DCI) ...
- CBN-S Ni-, Co-, Fe- and Cr-Alloys, Titanium, Titanium Alloys ...
- CBN-H Steel hardened up to 72 HRC, Cast Iron hardened ...
- CBN-X Tool Steel hardened, Stellite, Stainless Steel hardened, powder metallurgical Steel ...

You will find further application ranges in the detailed overview on page 8.

Special tools on request for you!  
Please send inquiries to [info@diamond-toolingsystems.com](mailto:info@diamond-toolingsystems.com)

All our products are also available in the online shop.  
Visit us at [diamond-tools24.com](http://diamond-tools24.com)

You can find our complete **holder program** in our tool holder catalog or in our online shop.

Subject to technical changes.

# TNGA

edge tipped

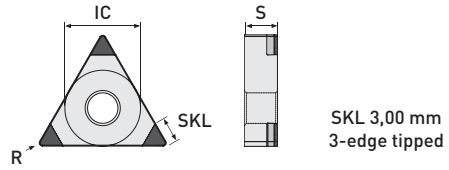
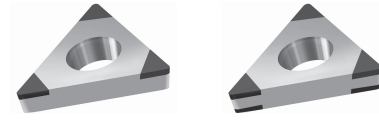

	ISO Code	IC	S	R	P25	P45	K65	K85	S85
					Item No.	Item No.	Item No.	Item No.	Item No.
Standard	TNGA 160402	9,525	4,76	0,20	TI5510-0790	TI5510-0791	TI5510-0792	TI5510-0793	TI5510-3602
	TNGA 160404	9,525	4,76	0,40	TI5510-0795	TI5510-0796	TI5510-0797	TI5510-0798	TI5510-3604
	TNGA 160408	9,525	4,76	0,80	TI5510-0800	TI5510-0801	TI5510-0802	TI5510-0803	TI5510-3606
	TNGA 160412	9,525	4,76	1,20	TI5510-0805	TI5510-0806	TI5510-0807	TI5510-0808	TI5510-3608

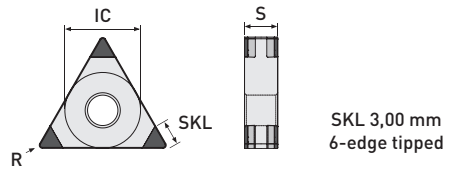

	ISO Code	IC	S	R	P25	P45	K65	K85	S85
					Item No.	Item No.	Item No.	Item No.	Item No.
Standard	TNGA 160402	9,525	4,76	0,20	TI5510-0815	TI5510-0816	TI5510-0817	TI5510-0818	
	TNGA 160404	9,525	4,76	0,40	TI5510-0820	TI5510-0821	TI5510-0822	TI5510-0823	
	TNGA 160408	9,525	4,76	0,80	TI5510-0825	TI5510-0826	TI5510-0827	TI5510-0828	
	TNGA 160412	9,525	4,76	1,20	TI5510-0830	TI5510-0831	TI5510-0832	TI5510-0833	

### Application range:

- CBN-P Sintered Steel ...
- CBN-K Grey Cast Iron (GCI), Ductile Cast Iron (DCI) ...
- CBN-S Ni-, Co-, Fe- and Cr-Alloys, Titanium, Titanium Alloys ...
- CBN-H Steel hardened up to 72 HRC, Cast Iron hardened ...
- CBN-X Tool Steel hardened, Stellite, Stainless Steel hardened, powder metallurgical Steel ...

You will find further application ranges in the detailed overview on page 8.

Detailed informations about cutting parameters and cooling can be found on page 56.

- continuous cut
- light interrupted cut
- heavy interrupted cut

Allrounder - hardened Steels							Version
H25	H35	H45	H65	H85	X90	X95	
	2. Alternative	1. Alternative	1. Choice				
Item No.	Item No.	Item No.	Item No.	Item No.	Item No.	Item No.	Item No.
TI5010-0790	TI5010-3602	TI5010-0791	TI5010-0792	TI5010-0793	TI5910-0792	TI5910-0793	3-edge tipped
TI5010-0795	TI5010-3604	TI5010-0796	TI5010-0797	TI5010-0798	TI5910-0797	TI5910-0798	3-edge tipped
TI5010-0800	TI5010-3606	TI5010-0801	TI5010-0802	TI5010-0803	TI5910-0802	TI5910-0803	3-edge tipped
TI5010-0805	TI5010-3608	TI5010-0806	TI5010-0807	TI5010-0808	TI5910-0807	TI5910-0808	3-edge tipped

Allrounder - hardened Steels							Version
H25	H35	H45	H65	H85	X90	X95	
	2. Alternative	1. Alternative	1. Choice				
Item No.	Item No.	Item No.	Item No.	Item No.	Item No.	Item No.	Item No.
TI5010-0815		TI5010-0816	TI5010-0817	TI5010-0818	TI5910-0817	TI5910-0818	6-edge tipped
TI5010-0820		TI5010-0821	TI5010-0822	TI5010-0823	TI5910-0822	TI5910-0823	6-edge tipped
TI5010-0825		TI5010-0826	TI5010-0827	TI5010-0828	TI5910-0827	TI5910-0828	6-edge tipped
TI5010-0830		TI5010-0831	TI5010-0832	TI5010-0833	TI5910-0832	TI5910-0833	6-edge tipped

Special tools on request for you!  
Please send inquiries to [info@diamond-toolingsystems.com](mailto:info@diamond-toolingsystems.com)

All our products are also available in the online shop.  
Visit us at [diamond-tools24.com](http://diamond-tools24.com)

You can find our complete holder program in our tool holder catalog or in our online shop.

Subject to technical changes.



# VBGW

edge tipped

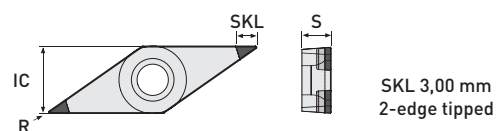
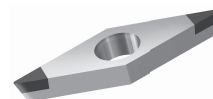

				P25	P45	K65	K85	S85
ISO Code	IC	S	R	Item No.	Item No.	Item No.	Item No.	Item No.
VBGW 070201	3,97	2,38	0,10			TI5510-1264		
VBGW 070202	3,97	2,38	0,20	TI5510-0840	TI5510-0841	TI5510-0842	TI5510-0843	TI5510-3652
VBGW 070204	3,97	2,38	0,40	TI5510-0845	TI5510-0846	TI5510-0847	TI5510-0848	TI5510-3654
VBGW 110201	6,35	2,38	0,10			TI5510-1265		
VBGW 110202	6,35	2,38	0,20	TI5510-0855	TI5510-0856	TI5510-0857	TI5510-0858	TI5510-3672
VBGW 110204	6,35	2,38	0,40	TI5510-0860	TI5510-0861	TI5510-0862	TI5510-0863	TI5510-3674
VBGW 110208	6,35	2,38	0,80	TI5510-0865	TI5510-0866	TI5510-0867	TI5510-0868	TI5510-3676
VBGW 160401	9,525	4,76	0,10			TI5510-1267		
VBGW 160402	9,525	4,76	0,20	TI5510-0875	TI5510-0876	TI5510-0877	TI5510-0878	TI5510-3682
VBGW 160404	9,525	4,76	0,40	TI5510-0880	TI5510-0881	TI5510-0882	TI5510-0883	TI5510-3684
VBGW 160408	9,525	4,76	0,80	TI5510-0885	TI5510-0886	TI5510-0887	TI5510-0888	TI5510-3686

Standard

Detailed informations about cutting parameters and cooling can be found on page 56.

- continuous cut
- light interrupted cut
- heavy interrupted cut

Allrounder - hardened Steels							
H25	H35	H45	H65	H85	X90	X95	
	2. Alternative	1. Alternative	1. Choice				
Item No.	Item No.	Item No.	Item No.	Item No.	Item No.	Item No.	Version
TI5010-1264					TI5910-1264		2-edge tipped
TI5010-0840	TI5010-3652	TI5010-0841	TI5010-0842	TI5010-0843	TI5910-0842	TI5910-0843	2-edge tipped
TI5010-0845	TI5010-3654	TI5010-0846	TI5010-0847	TI5010-0848	TI5910-0847	TI5910-0848	2-edge tipped
TI5010-1265					TI5910-1265		2-edge tipped
TI5010-0855	TI5010-3672	TI5010-0856	TI5010-0857	TI5010-0858	TI5910-0857	TI5910-0858	2-edge tipped
TI5010-0860	TI5010-3674	TI5010-0861	TI5010-0862	TI5010-0863	TI5910-0862	TI5910-0863	2-edge tipped
TI5010-0865	TI5010-3676	TI5010-0866	TI5010-0867	TI5010-0868	TI5910-0867	TI5910-0868	2-edge tipped
TI5010-1267					TI5910-1267		2-edge tipped
TI5010-0875	TI5010-3682	TI5010-0876	TI5010-0877	TI5010-0878	TI5910-0877	TI5910-0878	2-edge tipped
TI5010-0880	TI5010-3684	TI5010-0881	TI5010-0882	TI5010-0883	TI5910-0882	TI5910-0883	2-edge tipped
TI5010-0885	TI5010-3686	TI5010-0886	TI5010-0887	TI5010-0888	TI5910-0887	TI5910-0888	2-edge tipped

### Application range:

- CBN-P Sintered Steel ...
- CBN-K Grey Cast Iron (GCI), Ductile Cast Iron (DCI) ...
- CBN-S Ni-, Co-, Fe- and Cr-Alloys, Titanium, Titanium Alloys ...
- CBN-H Steel hardened up to 72 HRC, Cast Iron hardened ...
- CBN-X Tool Steel hardened, Stellite, Stainless Steel hardened, powder metallurgical Steel ...

You will find further application ranges in the detailed overview on page 8.

Special tools on request for you!  
Please send inquiries to [info@diamond-toolingsystems.com](mailto:info@diamond-toolingsystems.com)

All our products are also available in the online shop.  
Visit us at [diamond-tools24.com](http://diamond-tools24.com)

You can find our complete holder program in our tool holder catalog or in our online shop.

Subject to technical changes.

# VCGW

edge tipped

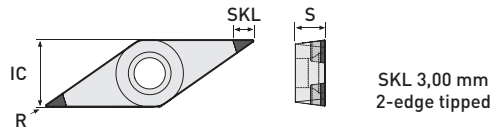

	P25	P45	K65	K85	S85
Item No.	Item No.	Item No.	Item No.	Item No.	Item No.

	ISO Code			Item No.	Item No.	Item No.	Item No.	Item No.	
	IC	S	R						
MiniTools	VCGW 050101 (SKL 2,00)	3,10	1,59	0,10			TI5510-2528		
	VCGW 050102 (SKL 2,00)	3,10	1,59	0,20			TI5510-2530		
	VCGW 050104 (SKL 2,00)	3,10	1,59	0,40			TI5510-2532		
Standard	VCGW 070201	3,97	2,38	0,10			TI5510-1274		
	VCGW 070202	3,97	2,38	0,20	TI5510-0960	TI5510-0961	TI5510-0962	TI5510-0963	TI5510-3702
	VCGW 070204	3,97	2,38	0,40	TI5510-0965	TI5510-0966	TI5510-0967	TI5510-0968	TI5510-3704
	VCGW 110301	6,35	3,18	0,10			TI5510-1275		
	VCGW 110302	6,35	3,18	0,20	TI5510-0975	TI5510-0976	TI5510-0977	TI5510-0978	TI5510-3722
	VCGW 110304	6,35	3,18	0,40	TI5510-0980	TI5510-0981	TI5510-0982	TI5510-0983	TI5510-3724
	VCGW 110308	6,35	3,18	0,80	TI5510-0985	TI5510-0986	TI5510-0987	TI5510-0988	TI5510-3726
	VCGW 160401	9,525	4,76	0,10			TI5510-1277		
	VCGW 160402	9,525	4,76	0,20	TI5510-0995	TI5510-0996	TI5510-0997	TI5510-0998	TI5510-3742
	VCGW 160404	9,525	4,76	0,40	TI5510-1000	TI5510-1001	TI5510-1002	TI5510-1003	TI5510-3744
Scharf	VCGW 160408	9,525	4,76	0,80	TI5510-1005	TI5510-1006	TI5510-1007	TI5510-1008	TI5510-3746
	VCGW 160412	9,525	4,76	1,20	TI5510-1010	TI5510-1011	TI5510-1012	TI5510-1013	TI5510-3748
	VCGW 070202-F	3,97	2,38	0,20			TI5510-2672		
	VCGW 070204-F	3,97	2,38	0,40			TI5510-2674		
	VCGW 110302-F	6,35	3,18	0,20			TI5510-2682		
	VCGW 110304-F	6,35	3,18	0,40			TI5510-2684		
VCGW 160402-F	9,525	4,76	0,20			TI5510-2692			
VCGW 160404-F	9,525	4,76	0,40			TI5510-2694			

You can find the matching MiniTool holders for plate size 05 in our precision boring tools catalogue (03).

### Application range:

- CBN-P Sintered Steel ...
- CBN-K Grey Cast Iron (GCI), Ductile Cast Iron (DCI) ...
- CBN-S Ni-, Co-, Fe- and Cr-Alloys, Titanium, Titanium Alloys ...
- CBN-H Steel hardened up to 72 HRC, Cast Iron hardened ...
- CBN-X Tool Steel hardened, Stellite, Stainless Steel hardened, powder metallurgical Steel ...

You will find further application ranges in the detailed overview on page 8.

Detailed informations about cutting parameters and cooling can be found on page 56.

- continuous cut
- light interrupted cut
- heavy interrupted cut

Allrounder - hardened Steels							Version
H25	H35	H45	H65	H85	X90	X95	
	2. Alternative	1. Alternative	1. Choice				
Item No.	Item No.	Item No.	Item No.	Item No.	Item No.	Item No.	Version
			TI5010-1561		TI5910-2528		2-edge tipped
			TI5010-1562		TI5910-2530		2-edge tipped
			TI5010-1563		TI5910-2532		2-edge tipped
TI5010-1274					TI9510-1274		2-edge tipped
TI5010-0960	TI5010-3702	TI5010-0961	TI5010-0962	TI5010-0963	TI5910-0962	TI5910-0963	2-edge tipped
TI5010-0965	TI5010-3704	TI5010-0966	TI5010-0967	TI5010-0968	TI5910-0967	TI5910-0968	2-edge tipped
TI5010-1275					TI5910-1275		2-edge tipped
TI5010-0975	TI5010-3722	TI5010-0976	TI5010-0977	TI5010-0978	TI5910-0977	TI5910-0978	2-edge tipped
TI5010-0980	TI5010-3724	TI5010-0981	TI5010-0982	TI5010-0983	TI5910-0982	TI5910-0983	2-edge tipped
TI5010-0985	TI5010-3726	TI5010-0986	TI5010-0987	TI5010-0988	TI5910-0987	TI5910-0988	2-edge tipped
TI5010-1277					TI5910-1277		2-edge tipped
TI5010-0995	TI5010-3742	TI5010-0996	TI5010-0997	TI5010-0998	TI5910-0997	TI5910-0998	2-edge tipped
TI5010-1000	TI5010-3744	TI5010-1001	TI5010-1002	TI5010-1003	TI5910-1002	TI5910-1003	2-edge tipped
TI5010-1005	TI5010-3746	TI5010-1006	TI5010-1007	TI5010-1008	TI5910-1007	TI5910-1008	2-edge tipped
TI5010-1010	TI5010-3748	TI5010-1011	TI5010-1012	TI5010-1013	TI5910-1012	TI5910-1013	2-edge tipped
TI5010-2472					TI5910-2672		2-edge tipped
TI5010-2474					TI5910-2674		2-edge tipped
TI5010-2482					TI5910-2682		2-edge tipped
TI5010-2484					TI5910-2684		2-edge tipped
TI5010-2492					TI5910-2692		2-edge tipped
TI5010-2494					TI5910-2694		2-edge tipped

Special tools on request for you!  
Please send inquiries to [info@diamond-toolingsystems.com](mailto:info@diamond-toolingsystems.com)

All our products are also available in the online shop.  
Visit us at [diamond-tools24.com](http://diamond-tools24.com)

You can find our complete holder program in our tool holder catalog or in our online shop.

Subject to technical changes.



# VNGA

edge tipped

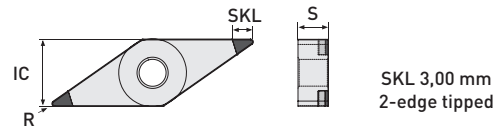
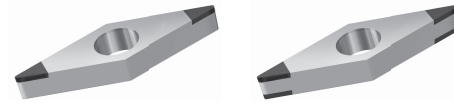

SKL 3,00 mm  
2-edge tipped

	P25	P45	K65	K85	S85			
ISO Code	IC	S	R	Item No.	Item No.	Item No.	Item No.	Item No.
VNGA 160402	9,525	4,76	0,20	TI5510-1020	TI5510-1021	TI5510-1022	TI5510-1023	TI5510-3782
VNGA 160404	9,525	4,76	0,40	TI5510-1025	TI5510-1026	TI5510-1027	TI5510-1028	TI5510-3784
VNGA 160408	9,525	4,76	0,80	TI5510-1030	TI5510-1031	TI5510-1032	TI5510-1033	TI5510-3786
VNGA 160412	9,525	4,76	1,20	TI5510-1035	TI5510-1036	TI5510-1037	TI5510-1038	TI5510-3788

Standard

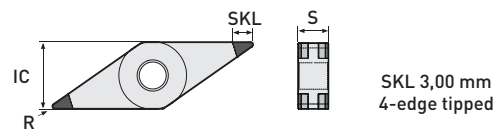

SKL 3,00 mm  
4-edge tipped

	P25	P45	K65	K85	S85			
ISO Code	IC	S	R	Item No.	Item No.	Item No.	Item No.	Item No.
VNGA 160402	9,525	4,76	0,20	TI5510-1045	TI5510-1046	TI5510-1047	TI5510-1048	
VNGA 160404	9,525	4,76	0,40	TI5510-1050	TI5510-1051	TI5510-1052	TI5510-1053	
VNGA 160408	9,525	4,76	0,80	TI5510-1055	TI5510-1056	TI5510-1057	TI5510-1058	
VNGA 160412	9,525	4,76	1,20	TI5510-1060	TI5510-1061	TI5510-1062	TI5510-1063	

Standard

### Application range:

- CBN-P Sintered Steel ...
- CBN-K Grey Cast Iron (GCI), Ductile Cast Iron (DCI) ...
- CBN-S Ni-, Co-, Fe- and Cr-Alloys, Titanium, Titanium Alloys ...
- CBN-H Steel hardened up to 72 HRC, Cast Iron hardened ...
- CBN-X Tool Steel hardened, Stellite, Stainless Steel hardened, powder metallurgical Steel ...

You will find further application ranges in the detailed overview on page 8.

Detailed informations about cutting parameters and cooling can be found on page 56.

- continuous cut
- light interrupted cut
- heavy interrupted cut

### Allrounder - hardened Steels

H25	H35	H45	H65	H85	X90	X95	Version
	2. Alternative	1. Alternative	1. Choice				
Item No.	Item No.	Item No.	Item No.	Item No.	Item No.	Item No.	Version
TI5010-1020	TI5010-3782	TI5010-1021	TI5010-1022	TI5010-1023	TI5910-1022	TI5910-1023	2-edge tipped
TI5010-1025	TI5010-3784	TI5010-1026	TI5010-1027	TI5010-1028	TI5910-1027	TI5910-1028	2-edge tipped
TI5010-1030	TI5010-3786	TI5010-1031	TI5010-1032	TI5010-1033	TI5910-1032	TI5910-1033	2-edge tipped
TI5010-1035	TI5010-3788	TI5010-1036	TI5010-1037	TI5010-1038	TI5910-1037	TI5910-1038	2-edge tipped

### Allrounder - hardened Steels

H25	H35	H45	H65	H85	X90	X95	Version
	2. Alternative	1. Alternative	1. Choice				
Item No.	Item No.	Item No.	Item No.	Item No.	Item No.	Item No.	Version
TI5010-1045		TI5010-1046	TI5010-1047	TI5010-1048	TI5910-1047	TI5910-1048	4-edge tipped
TI5010-1050		TI5010-1051	TI5010-1052	TI5010-1053	TI5910-1052	TI5910-1053	4-edge tipped
TI5010-1055		TI5010-1056	TI5010-1057	TI5010-1058	TI5910-1057	TI5910-1058	4-edge tipped
TI5010-1060		TI5010-1061	TI5010-1062	TI5010-1063	TI5910-1062	TI5010-1063	4-edge tipped



Special tools on request for you!  
Please send inquiries to [info@diamond-toolingsystems.com](mailto:info@diamond-toolingsystems.com)



All our products are also available in the online shop.  
Visit us at [diamond-tools24.com](http://diamond-tools24.com)

You can find our complete holder program in our tool holder catalog or in our online shop.

Subject to technical changes.

# VXGW

edge tipped

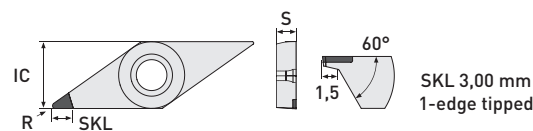

SKL 3,00 mm  
1-edge tipped

	ISO Code	IC	S	R	P25	P45	K65	K85	S85
					Item No.	Item No.	Item No.	Item No.	Item No.
DTS-Specials	VXGW 160401	9,525	4,76	0,10			TI5510-1650		
	VXGW 160402	9,525	4,76	0,20			TI5510-1655		
	VXGW 160404	9,525	4,76	0,40			TI5510-1660		

! The matching holders on request, available from stock.

## DTS-Specials Plan/Axial Machining:

Our VXGW cutting insert is designed for face and axial machining of contours from a minimum outside diameter of 10mm, using the maximum groove depth of 1.5mm.

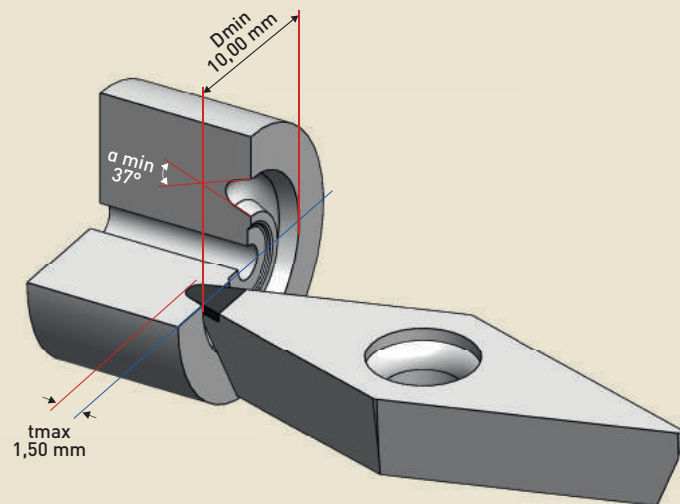

Standardmäßig mit CBN-K65, H25 und X90 bestückt, aber on request selbstverständlich auch with allen anderen CBN-Types erhältlich.

### Application range:

- CBN-P Sintered Steel ...
- CBN-K Grey Cast Iron (GCI), Ductile Cast Iron (DCI) ...
- CBN-S Ni-, Co-, Fe- and Cr-Alloys, Titanium, Titanium Alloys ...
- CBN-H Steel hardened up to 72 HRC, Cast Iron hardened ...
- CBN-X Tool Steel hardened, Stellite, Stainless Steel hardened, powder metallurgical Steel ...

You will find further application ranges in the detailed overview on page 8.

**i** Detailed informations about cutting parameters and cooling can be found on page 56.

- continuous cut
- ◐ light interrupted cut
- ◑ heavy interrupted cut

### Allrounder - hardened Steels

H25	H35	H45	H65	H85	X90	X95	Version
	2. Alternative	1. Alternative	1. Choice				
●	● ◐ ◑	● ◐ ◑	● ◐ ◑	◐ ◑	● ◐ ◑	◐ ◑	
Item No.	Item No.	Item No.	Item No.	Item No.	Item No.	Item No.	Version
TI5010-1650					TI5910-1650		1-edge tipped
TI5010-1655					TI5910-1655		1-edge tipped
TI5010-1660					TI5910-1660		1-edge tipped

**!** Special tools on request for you!  
Please send inquiries to [info@diamond-toolingsystems.com](mailto:info@diamond-toolingsystems.com)

**!** All our products are also available in the online shop.  
Visit us at [diamond-tools24.com](http://diamond-tools24.com)

You can find our complete holder program in our tool holder catalog or in our online shop.

Subject to technical changes.

# WCGW

edge tipped

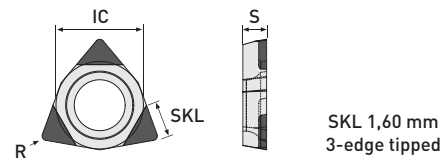
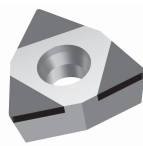

	P25	P45	K65	K85	S85			
ISO Code	IC	S	R	Item No.	Item No.	Item No.	Item No.	Item No.
WCGW 020101	3,97	1,59	0,10			TI5510-2534		
WCGW 020102	3,97	1,59	0,20			TI5510-2536		
WCGW 020104	3,97	1,59	0,40			TI5510-2538		

MiniTools

You will find the matching MiniTool holder in our boring bar catalog [03] on page [03].

Detailed informations about cutting parameters and cooling can be found on page 56.

- continuous cut
- light interrupted cut
- heavy interrupted cut

Allrounder - hardened Steels							Version
H25	H35	H45	H65	H85	X90	X95	
	2. Alternative	1. Alternative	1. Choice				
Item No.	Item No.	Item No.	Item No.	Item No.	Item No.	Item No.	Item No.
			TI5010-1571		TI5910-2534		3-edge tipped
			TI5010-1572		TI5910-2536		3-edge tipped
			TI5010-1573		TI5910-2538		3-edge tipped

### Application range:

- CBN-P Sintered Steel ...
- CBN-K Grey Cast Iron (GCI), Ductile Cast Iron (DCI) ...
- CBN-S Ni-, Co-, Fe- and Cr-Alloys, Titanium, Titanium Alloys ...
- CBN-H Steel hardened up to 72 HRC, Cast Iron hardened ...
- CBN-X Tool Steel hardened, Stellite, Stainless Steel hardened, powder metallurgical Steel ...

You will find further application ranges in the detailed overview on page 8.

Special tools on request for you!  
Please send inquiries to [info@diamond-toolingsystems.com](mailto:info@diamond-toolingsystems.com)

All our products are also available in the online shop.  
Visit us at [diamond-tools24.com](http://diamond-tools24.com)

You can find our complete holder program in our tool holder catalog or in our online shop.

Subject to technical changes.

# WNGA

edge tipped

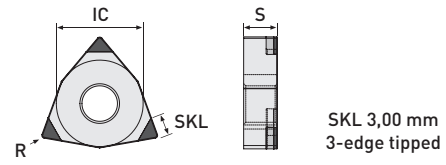
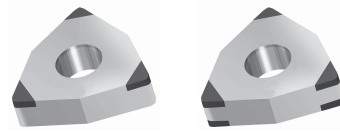

SKL 3,00 mm  
3-edge tipped

	ISO Code	IC	S	R	P25	P45	K65	K85	S85
					Item No.	Item No.	Item No.	Item No.	Item No.
Standard	WNGA 080402	12,70	4,76	0,20	TI5510-1070	TI5510-1071	TI5510-1072	TI5510-1073	TI5510-3902
	WNGA 080404	12,70	4,76	0,40	TI5510-1075	TI5510-1076	TI5510-1077	TI5510-1078	TI5510-3904
	WNGA 080408	12,70	4,76	0,80	TI5510-1080	TI5510-1081	TI5510-1082	TI5510-1083	TI5510-3906
	WNGA 080412	12,70	4,76	1,20	TI5510-1085	TI5510-1086	TI5510-1087	TI5510-1088	
Wiper	WNGA 080404 R/L-W	12,70	4,76	0,40	TI5510-1095	TI5510-1096	TI5510-1097	TI5510-1098	
	WNGA 080408 R/L-W	12,70	4,76	0,80	TI5510-1100	TI5510-1101	TI5510-1102	TI5510-1103	
	WNGA 080412 R/L-W	12,70	4,76	1,20	TI5510-1105	TI5510-1106	TI5510-1107	TI5510-1108	

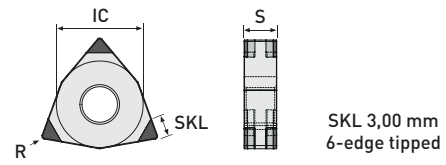

SKL 3,00 mm  
6-edge tipped

	ISO Code	IC	S	R	P25	P45	K65	K85	S85
					Item No.	Item No.	Item No.	Item No.	Item No.
Standard	WNGA 080402	12,70	4,76	0,20	TI5510-1115	TI5510-1116	TI5510-1117	TI5510-1118	
	WNGA 080404	12,70	4,76	0,40	TI5510-1120	TI5510-1121	TI5510-1122	TI5510-1123	
	WNGA 080408	12,70	4,76	0,80	TI5510-1125	TI5510-1126	TI5510-1127	TI5510-1128	
	WNGA 080412	12,70	4,76	1,20	TI5510-1130	TI5510-1131	TI5510-1132	TI5510-1133	
Wiper	WNGA 080404 R/L-W	12,70	4,76	0,40	TI5510-1140	TI5510-1141	TI5510-1142	TI5510-1143	
	WNGA 080408 R/L-W	12,70	4,76	0,80	TI5510-1145	TI5510-1146	TI5510-1147	TI5510-1148	
	WNGA 080412 R/L-W	12,70	4,76	1,20	TI5510-1150	TI5510-1151	TI5510-1152	TI5510-1153	

### Application range:

- CBN-P Sintered Steel ...
- CBN-K Grey Cast Iron (GCI), Ductile Cast Iron (DCI) ...
- CBN-S Ni-, Co-, Fe- and Cr-Alloys, Titanium, Titanium Alloys ...
- CBN-H Steel hardened up to 72 HRC, Cast Iron hardened ...
- CBN-X Tool Steel hardened, Stellite, Stainless Steel hardened, powder metallurgical Steel ...

You will find further application ranges in the detailed overview on page 8.

Detailed informations about cutting parameters and cooling can be found on page 56.

- continuous cut
- light interrupted cut
- heavy interrupted cut

Allrounder - hardened Steels							
H25	H35	H45	H65	H85	X90	X95	
	2. Alternative	1. Alternative	1. Choice				
Item No.	Item No.	Item No.	Item No.	Item No.	Item No.	Item No.	Version
TI5010-1070		TI5010-1071	TI5010-1072	TI5010-1073	TI5910-1072	TI5910-1073	3-edge tipped
TI5010-1075		TI5010-1076	TI5010-1077	TI5010-1078	TI5910-1077	TI5910-1078	3-edge tipped
TI5010-1080		TI5010-1081	TI5010-1082	TI5010-1083	TI5910-1082	TI5910-1083	3-edge tipped
TI5010-1085		TI5010-1086	TI5010-1087	TI5010-1088	TI5910-1087	TI5910-1088	3-edge tipped
TI5010-1095		TI5010-1096	TI5010-1097	TI5010-1098	TI5910-1097	TI5910-1098	3-edge tipped
TI5010-1100		TI5010-1101	TI5010-1102	TI5010-1103	TI5910-1102	TI5910-1103	3-edge tipped
TI5010-1105		TI5010-1106	TI5010-1107	TI5010-1108	TI5910-1107	TI5910-1108	3-edge tipped

Allrounder - hardened Steels							
H25	H35	H45	H65	H85	X90	X95	
	2. Alternative	1. Alternative	1. Choice				
Item No.	Item No.	Item No.	Item No.	Item No.	Item No.	Item No.	Version
TI5010-1115		TI5010-1116	TI5010-1117	TI5010-1118	TI5910-1117	TI5910-1118	6-edge tipped
TI5010-1120		TI5010-1121	TI5010-1122	TI5010-1123	TI5910-1122	TI5910-1123	6-edge tipped
TI5010-1125		TI5010-1126	TI5010-1127	TI5010-1128	TI5910-1127	TI5910-1128	6-edge tipped
TI5010-1130		TI5010-1131	TI5010-1132	TI5010-1133	TI5910-1132	TI5910-1133	6-edge tipped
TI5010-1140		TI5010-1141	TI5010-1142	TI5010-1143	TI5910-1142	TI5910-1143	6-edge tipped
TI5010-1145		TI5010-1146	TI5010-1147	TI5010-1148	TI5910-1147	TI5910-1148	6-edge tipped
TI5010-1150		TI5010-1151	TI5010-1152	TI5010-1153	TI5910-1152	TI5910-1153	6-edge tipped

Special tools on request for you!  
Please send inquiries to [info@diamond-toolingsystems.com](mailto:info@diamond-toolingsystems.com)

All our products are also available in the online shop.  
Visit us at [diamond-tools24.com](http://diamond-tools24.com)

You can find our complete holder program in our tool holder catalog or in our online shop.

Subject to technical changes.

# WNGA

edge tipped | with extended cutting edge for roughing and finishing

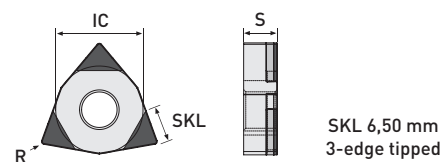
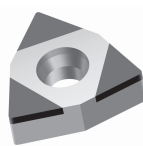

	P25	P45	K65	K85	S85
ISO Code	IC	S	R	Item No.	Item No.
<b>WNGA 080404</b>	12,70	4,76	0,40		TI5510-1291
<b>WNGA 080408</b>	12,70	4,76	0,80		TI5510-1292
<b>WNGA 080412</b>	12,70	4,76	1,20		TI5510-1293

DTS-Specials

Detailed informations about cutting parameters and cooling can be found on page 56.

- continuous cut
- light interrupted cut
- heavy interrupted cut

Allrounder - hardened Steels							
H25	H35	H45	H65	H85	X90	X95	
	2. Alternative	1. Alternative	1. Choice				
Item No.	Item No.	Item No.	Item No.	Item No.	Item No.	Item No.	Version
					TI5910-1291		3-edge tipped
					TI5910-1292		3-edge tipped
					TI5910-1293		3-edge tipped

### Application range:

- CBN-P Sintered Steel ...
- CBN-K Grey Cast Iron (GCI), Ductile Cast Iron (DCI) ...
- CBN-S Ni-, Co-, Fe- and Cr-Alloys, Titanium, Titanium Alloys ...
- CBN-H Steel hardened up to 72 HRC, Cast Iron hardened ...
- CBN-X Tool Steel hardened, Stellite, Stainless Steel hardened, powder metallurgical Steel ...

You will find further application ranges in the detailed overview on page 8.

Special tools on request for you!  
Please send inquiries to [info@diamond-toolingsystems.com](mailto:info@diamond-toolingsystems.com)

All our products are also available in the online shop.  
Visit us at [diamond-tools24.com](http://diamond-tools24.com)



You can find our complete **holder program** in our tool holder catalog or in our online shop.

Subject to technical changes.



# Cutting Parameters

for our CBN Grades

-  continuous cut
-  light interrupted cut
-  heavy interrupted cut

Material		P25			P45			K65			K85			S85		
		$V_c$ [m/min]	$a_p$ [mm]	F [mm/U]	$V_c$ [m/min]	$a_p$ [mm]	F [mm/U]	$V_c$ [m/min]	$a_p$ [mm]	F [mm/U]	$V_c$ [m/min]	$a_p$ [mm]	F [mm/U]	$V_c$ [m/min]	$a_p$ [mm]	F [mm/U]
Grey Cast Iron (GG)	min.							500	0,01	0,01	450	0,01	0,01			
	max.							2500	2,80	0,40	1400	2,80	0,35			
Ductile Cast Iron (GGG)	min.							250	0,01	0,01	200	0,01	0,01			
	max.							1200	2,80	0,35	1000	2,80	0,30			
Sintered Steel	min.	200	0,01	0,01	180	0,01	0,01									
	max.	400	2,60	0,30	300	2,00	0,30									
Ni-, Co-, Fe- and Cr-Alloys	min.												80	0,01	0,01	
	max.												350	0,50	0,30	
Titanium	min.												80	0,01	0,01	
	max.												240	0,50	0,30	









Subject to technical changes.

 Cutting data for hard turning can be found on page 58.

## Cooling recommended

In machining with CBN inserts, proper cooling is a key to successful machining.

Here you will find our recommendation:

		Dry	Air	Emulsion	Oil
P		4. Choice	3. Choice	1. Choice	2. Choice
		2. Choice	1. Choice		
		2. Choice	1. Choice		
K		4. Choice	3. Choice	1. Choice	2. Choice
		2. Choice	1. Choice		
		2. Choice	1. Choice		
S			3. Choice	1. Choice	2. Choice
			2. Choice	1. Choice	
		2. Choice	1. Choice	3. Choice	

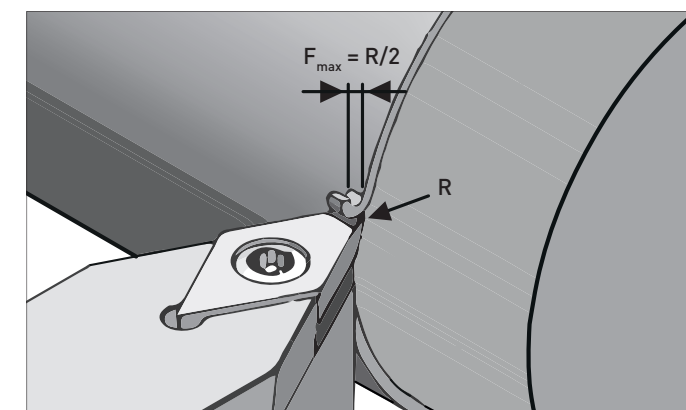

Never use max.  $a_p$  with max. feed rate

Significantly higher cutting depths and feeds can be realised with RNGN and SNGN Solid inserts.





If you have any further technical questions, please do not hesitate to contact us by phone or e-mail!

Phone: +49(0)6301 32011-0

Mail: [info@Diamond-toolingsystems.com](mailto:info@Diamond-toolingsystems.com)

# Cutting Parameters

for our CBN Grades

-  continuous cut
-  light interrupted cut
-  heavy interrupted cut







Material		H25			H35			H45			H65			H85		
		$V_c$ [m/min]	$a_p$ [mm]	F [mm/U]	$V_c$ [m/min]	$a_p$ [mm]	F [mm/U]	$V_c$ [m/min]	$a_p$ [mm]	F [mm/U]	$V_c$ [m/min]	$a_p$ [mm]	F [mm/U]	$V_c$ [m/min]	$a_p$ [mm]	F [mm/U]
Steel hardened up to 72 HRC	min.	100	0,01	0,01	100	0,01	0,01	100	0,01	0,01	100	0,01	0,01	80	0,01	0,01
	max.	300	1,50	0,50	260	1,50	0,50	260	1,00	0,40	240	1,00	0,40	220	1,00	0,40
Ball Bearing and Spring Steel	min.	100	0,01	0,01	100	0,01	0,01	100	0,01	0,01	100	0,01	0,01	80	0,01	0,01
	max.	400	1,00	0,30	360	1,00	0,50	360	0,50	0,50	360	0,50	0,50	200	0,40	0,30
Tool Steel, hardened up to 72 HRC	min.															
	max.															
Cold and hot work tool Steel, hardened up to 72 HRC	min.															
	max.															
Case hardened Steel	min.	100	0,01	0,01	100	0,01	0,01	100	0,01	0,01	100	0,01	0,01	80	0,01	0,01
	max.	300	1,50	0,50	260	1,50	0,50	260	1,00	0,40	240	1,00	0,40	220	1,00	0,40
Powder metallurgical Steel, hardened up to 72 HRC	min.															
	max.															
Cast Iron, hardened	min.	80	0,01	0,01	80	0,01	0,01	80	0,01	0,01	80	0,01	0,01	60	0,01	0,01
	max.	220	1,50	0,50	200	1,00	0,50	200	1,00	0,50	200	1,00	0,50	180	0,50	0,30
Sintered Steel, hardened	min.	100	0,01	0,01	100	0,01	0,01	100	0,01	0,01	100	0,01	0,01	80	0,01	0,01
	max.	300	1,50	0,50	260	1,50	0,50	260	1,00	0,40	240	1,00	0,40	220	1,00	0,40
Stainless Steel, hardened	min.															
	max.															
Stellite	min.															
	max.															
Hard and Soft Machining	min.	80	0,01	0,01	80	0,01	0,01	80	0,01	0,01	80	0,01	0,01	80	0,01	0,01
	max.	400	1,50	0,40	360	1,50	0,30	300	1,50	0,30	300	1,50	0,30	260	1,00	0,30

Subject to technical changes.

Material		X90			X95		
		$V_c$ [m/min]	$a_p$ [mm]	F [mm/U]	$V_c$ [m/min]	$a_p$ [mm]	F [mm/U]
Steel hardened up to 72 HRC	min.	100	0,01	0,01	100	0,01	0,01
	max.	300	1,50	0,50	260	1,50	0,50
Ball Bearing and Spring Steel	min.	100	0,01	0,01	100	0,01	0,01
	max.	400	1,00	0,30	360	1,00	0,50
Tool Steel, hardened up to 72 HRC	min.						
	max.						
Cold and hot work tool Steel, hardened up to 72 HRC	min.						
	max.						
Case hardened Steel	min.	100	0,01	0,01	100	0,01	0,01
	max.	300	1,50	0,50	260	1,50	0,50
Powder metallurgical Steel, hardened up to 72 HRC	min.						
	max.						
Cast Iron, hardened	min.	80	0,01	0,01	80	0,01	0,01
	max.	220	1,50	0,50	200	1,00	0,50
Sintered Steel, hardened	min.	100	0,01	0,01	100	0,01	0,01
	max.	300	1,50	0,50	260	1,50	0,50
Stainless Steel, hardened	min.						
	max.						
Stellite	min.						
	max.						
Hard and Soft Machining	min.	80	0,01	0,01	80	0,01	0,01
	max.	400	1,50	0,40	360	1,50	0,30

## Cooling recommendation

When machining with CBN inserts, proper cooling is a key to successful machining. Here you will find our recommendation by cutting condition.

		Dry	Air	Emulsion	Oil
H		4. Choice	3. Choice	1. Choice	2. Choice
		2. Choice	1. Choice	3. Choice	
		2. Choice	1. Choice		
X		4. Choice	3. Choice	1. Choice	2. Choice
		2. Choice	1. Choice		
		2. Choice	1. Choice		

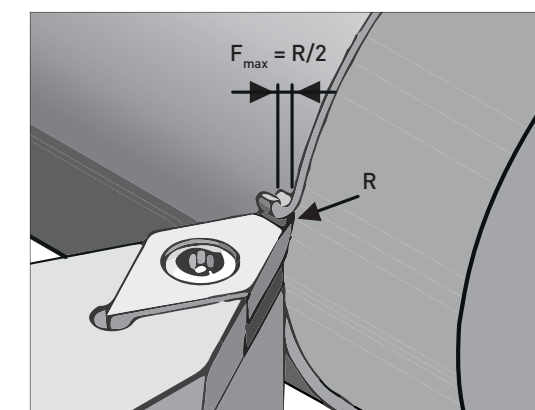

Never use max.  $a_p$  with max. feed rate

With RNGN and SNGN-Solid inserts, significantly higher cutting depths and feeds can be achieved. feed rates can be realised.



If you have any further technical questions, please do not hesitate to contact us by phone or e-mail!

Phone: +49(0)6301 32011-0

Mail: [info@Diamond-toolingsystems.com](mailto:info@Diamond-toolingsystems.com)







Instagram



YouTube



LinkedIn



DTS Shop



DTS Webseite



**PASSION FOR DIAMOND**

Hans-Geiger-Straße 11a · D-67661 Kaiserslautern

+49 (0) 6301 32011-0

+49 (0) 6301 32011-90

[info@Diamond-toolingsystems.com](mailto:info@Diamond-toolingsystems.com)

Homepage: [www.Diamond-toolingsystems.com](http://www.Diamond-toolingsystems.com)

Shop: [www.Diamond-tools24.com](http://www.Diamond-tools24.com)