

Diamond Cutting Inserts

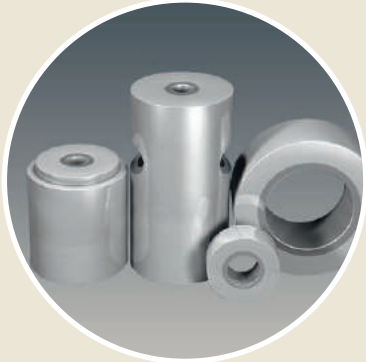

Die and Mold
Industry

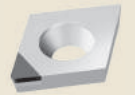

Automotive
Mechanical Engineering

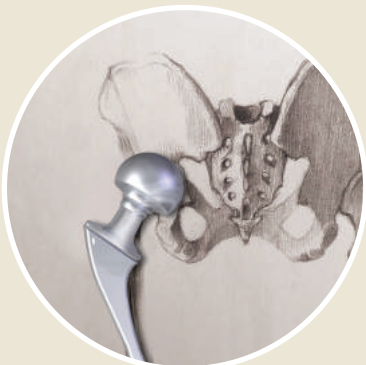
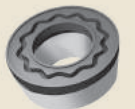
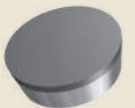

Medical Technology
Micro Technology

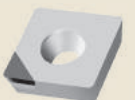
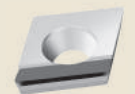

Aerospace
Engineering

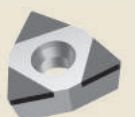



Welcome to DTS - Diamond Tooling Systems GmbH!

Based in Kaiserslautern - Germany - we have specialized in the development, production and distribution of precision tools equipped with ultrahard cutting materials, such as PCD (polycrystalline Diamond), CVD-D (CVD thickfilm Diamond), UltraDiamond (monocrystalline binderless Diamond) and CBN (cubic boron nitride). As a leading manufacturer for tools with lasered cutting edges, we offer machining solutions in the areas of turning, milling, grooving, drilling, reaming, threading, and tool holding.

To be able to economically process ultra-hard cutting materials such as PCD, CVD-D and CBN on precision tools werealized early on that we would have to move away from the traditional production technology of „grinding“ to new technologies such as the „laser removal process“. This decision has contributed to the fact that our customers regard us, DTS GmbH, as the pioneer and leading manufacturer of lasered tools for machining.

Ultra-hard high-performance cutting materials have a key function in Metal-cutting manufacturing. Precision tool-equipped with ultra-hard cutting materials are products that require a great deal of explanation. The economical use of the cutting materials is only ensured if the machining process and the cutting material are coordinated with each other.

This is exactly where we at DTS - Diamond Tooling Systems GmbH - step in: Tools and processes are subjected to a comprehensive analysis by our experienced application engineers. Subsequently, the new process optimization is presented to the customer and in the next step, it is implemented in their production. Only in that way is it possible to exploit the optimum potential of our high-tech cutting materials.

Our experienced application engineers are also available to advise you during ongoing production. This close cooperation and mutual trust is the basis of our success.

With more than 25 years of optimization experience in the processing industry, this is where we see our strength!

Overview

Ultrahard Cutting Materials at a Glance	04
Our Cutting Materials and their main areas of application	06
Our Cutting Material allocation according for Material use	07
3D - lasered Micro Chip Grooves	08
Wiper inserts, mode of operation	09
Application examples - our Cutting edges in use	10
ISO Code	11

Products

CCGT - positive Rake Angle and Chip Breaker	12
CCGW - neutral	16
CDGW - neutral	18
CNGA - neutral	19
CPGT - positive Rake Angle and Chip Breaker	20
CPGW - neutral	22
DCGT - positive Rake Angle and Chip Breaker	24
DCGW - neutral	26
DCGW - Standard and Wiper - R / L for Face Turning	27
DCGW - Wiper - Right and Left for Side Turning	28
DCGT - Wiper with Chip Breaker for Side Turning	29
DNGA - neutral	31
DXGW - neutral	32
EPGW - neutral	33
RBGN - neutral	34
RCGW - neutral	35
SCGT - Positive Rake Angle	36
SCGW - neutral	36
TCGT - Positive Rake Angle and Chip Breaker	38
TCGW - neutral	42
TPGN - neutral	44
TPGW - neutral	45
VBGT - Positive Rake Angle	46
VBGW - neutral	47
VCGT - Positive Rake Angle and Chip Breaker	48
VCGW - neutral	50
VXGW - neutral	51
WCGW - neutral	52

Technical Attachment

Cutting Data	54
Formulary	58

PASSION FOR DIAMOND...

ultrahard cutting materials at a glance

... is not just a slogan for us - we live this passion in our daily dealings with our customers and we are your partner when it comes to Diamond or CBN tools.

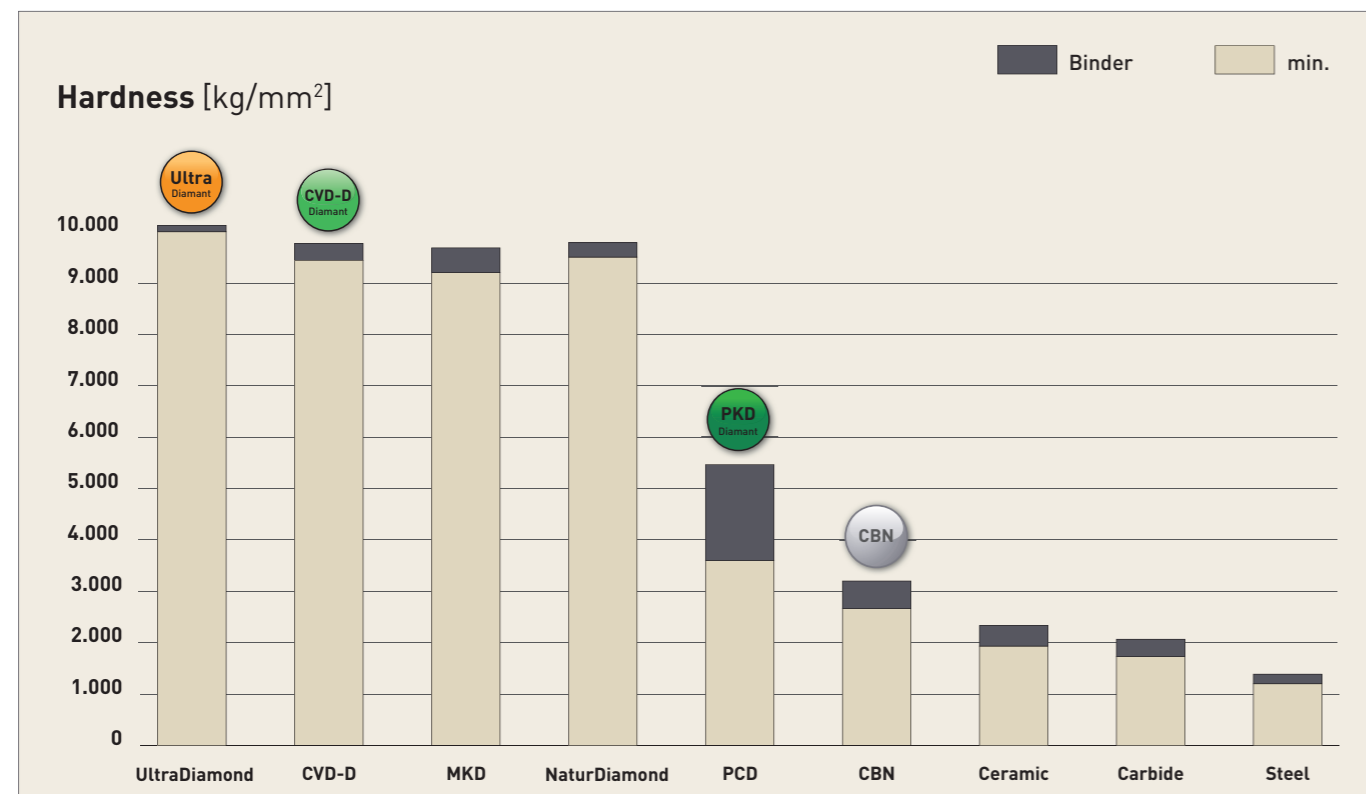

Polycrystalline Diamond (PCD)

The well-known standard Diamond

PCD is a synthetically produced, extremely tough, intergrown mass of Diamond particles with random orientation in a Metal matrix. It is produced by sintering selected Diamond particles at high pressure and high temperatures.

Graphite is used as a catalyst so that the PCD crystals grow together. PCD has high thermal conductivity and good heat dissipation from the cutting area. In addition, PCD has the highest bending strength of all cutting materials bending strength of all cutting materials.

PCD is very well suited for machining aluminium with a Si content of up to 10% and/or other abrasive fillers. The hot hardness is approx. 750°C, the areas of application are similar to those of CVD thick film Diamond, but the high efficiency of CVD thick film Diamond comes into its own with hard-brittle materials or aluminium with a Si content of 10% or more.

CVD thick film Diamond (CVD-D)

The star among Diamond Cutting Materials

For machining hard-brittle materials such as ceramics, glass, glass-ceramics, hard Metal, MMC and fibre composites such as CFK and GFK. Due to the lack of a bonding matrix, the Diamond content is much higher than with PCD. In the group of ultra-hard cutting materials, the binderless CVD-D is one of the hardest, artificially produced Diamond cutting materials.

CVD-D is characterised by high hardness and high wear resistance. These properties make CVD-D the perfect cutting material for machining abrasive materials. Compared to PCD, which is damaged by the abrasive particles due to its soft metallic binder phase, the CVD-D cutting edge remains stable due to its binderless anchoring in the Diamond matrix.

If CVD-D is used correctly, the service life can be increased by up to 10 times (and even more) compared to PCD!

Binderless Diamond (UltraDiamond)

The hardest single Crystal

Single-crystal elements are laser-cut from Diamond blanks in a defined orientation using laser segmentation technology. This new technology makes it possible, in addition to polycrystalline cutting materials such as PCD and CVD-D, to also braze a monocrystal (UltraDiamond) under high vacuum on any tool carrier. Compared to PCD, the tool life can be increased by approx. 15 to 25 times and compared to CVD-D by approx. 2 to 5 times.

The areas of application are similar to PCD and CVD-D, but this monocrystalline cutting material offers a further significant increase in tool life in all applications where PCD and CVD-D reach the limits of economic viability. The UltraDiamond cutting material makes economical machining of very hard, highly brittle materials such as Ceramics, glass, glass-Ceramics and hard metals with low cobalt binder and nickel binder (<10%) possible. Ceramics, glass, glass-ceramics and hard metals with low cobalt binder and nickel binder (<10%).

Polycrystalline Cubic Boron Nitride (CBN)

Chemically resistant and stable at high temperatures

CBN is stable up to 1,400°C. Boron nitride powder is the starting point for the production of CBN, which has been available since the late 1960s. It is produced under high pressure as well as at temperatures of over 1,500°C and is specially adapted to the final application through many different substrates.

Today, CBN is considered the second hardest material after Diamond cutting materials!

The applications of CBN are in the automotive industry, aerospace, tool and mould making and mechanical engineering. The wide spectrum as a cutting and abrasive material includes hardened Steels, Cast Iron, chilled Cast Iron, sintered materials, stellite, nickel and cobalt-based superalloys. In many applications, cubic boron nitride is preferred over Diamond cutting materials because it is absolutely stable in air at temperatures up to 1,400°C. Diamond, on the other hand, starts to decompose at a temperature of about 750°C.

Compared to PCD, CBN is also characterised by its chemical resistance to ferrous materials.

Our Cutting Materials

and their main areas of application at a glance

We want to offer you the ideal solution for your application. Therefore, we also offer you a wide range of cutting materials on our internal turning tools.

Below you will find an overview of the different cutting materials.



PCD

is ideally suited for the machining of *

Aluminium <10% Si | Graphite | Ceramic green compact | Copper | Copper Alloy | Magnesium | Brass | PEEK | Tungsten Alloy



CVD-D

is ideally suited for the machining of *

Acrylic (PMMA) | Aluminium >10% Si | Glass, GlassCeramic | Carbide >10%Co | Ceramic | Plastics | Copper, Copper Alloys | Magnesium | Silver, Gold, Platinum | Titanium | Composites (CFRP, GFRP) | Zirconium



UltraDiamond

is ideally suited for the cutting of *

Acryl (PMMA) | Glas, GlasCeramic | Carbide <12%Co | Ceramic

Our Cutting Material Assignment

about the materials

You can't find your material in the table?

We will be happy to help you by phone or e-mail!

Tel.: +49(0)6301 32011-0

Mail: info@Diamond-toolingsystems.com

		1. Choice	Alternative	DTS Diamond Types		
		<input checked="" type="radio"/>	<input type="radio"/>	PCD	CVD-D	Ultra Diamond
ISO	Materials					
N	Acryl (PMMA)		<input type="radio"/>	<input checked="" type="radio"/>		
	Aluminium, < 10% Si	<input checked="" type="radio"/>	<input type="radio"/>			
	Aluminium, > 10% Si		<input checked="" type="radio"/>		<input type="radio"/>	
	Glas, GlasCeramic		<input type="radio"/>		<input checked="" type="radio"/>	
	Carbide (Green)	<input checked="" type="radio"/>	<input type="radio"/>			
	Carbide G-Type, < 12% Co		<input type="radio"/>			<input checked="" type="radio"/>
	Carbide G-Type, > 10% Co		<input checked="" type="radio"/>			<input type="radio"/>
	Carbide K-Type, < 12% Co		<input type="radio"/>			<input checked="" type="radio"/>
	Carbide K-Type, > 10% Co		<input checked="" type="radio"/>			<input type="radio"/>
	Carbide with Ni Binder					<input checked="" type="radio"/>
	Ceramic	<input checked="" type="radio"/>	<input type="radio"/>		<input type="radio"/>	
	Ceramic (Green)	<input checked="" type="radio"/>	<input type="radio"/>			
	Plastics	<input type="radio"/>	<input checked="" type="radio"/>			
	Copper, Copper Alloys	<input checked="" type="radio"/>	<input type="radio"/>			
	Magnesium	<input type="radio"/>	<input checked="" type="radio"/>			
	Brass	<input checked="" type="radio"/>	<input type="radio"/>			
	MMC	<input type="radio"/>	<input checked="" type="radio"/>			
PEEK	<input checked="" type="radio"/>	<input type="radio"/>			<input type="radio"/>	
Silver, Gold, Platinum		<input checked="" type="radio"/>			<input type="radio"/>	
Composite Materials like CFK/GFK	<input type="radio"/>	<input checked="" type="radio"/>				
Tungsten Alloy	<input type="radio"/>	<input checked="" type="radio"/>				

DTS cutting materials are successfully used in many industries:

- Mechanical Engineering
- Die and Mold Industry
- Automotive
- Aerospace
- Medical Technology
- optical Industry
- Ceramic Industry



3D - gelaserte Micro Chip Breaker

for optimized chip control

Diamond tools are the first choice for machining aluminium and magnesium alloys, lead-free brass and a wide variety of plastic composites. However, these long-chipping materials are always subject to chip problems.

Our laser technology enables us to insert 3D micro chip breakers into a wide variety of PCD, CVD-D and CBN tools. This special laser ablation process allows us to design complex chipbreaker shapes and achieve excellent chip control.

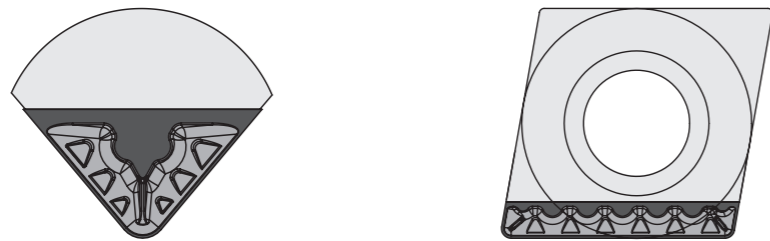

A lasered 3D micro chip breaker enables controlled chip breaking or chip guidance for most long-chipping materials. In addition, the chip breaker minimises the cutting pressure, which enables the machining of thin-walled components.

For controlled chip breaking, we offer you two different 3D-Micro chip breaker levels:

- Chip Breaker-F (sharp cutting edge for finishing chip)
- Chipbreaker-R (stable cutting edge for roughing chip)

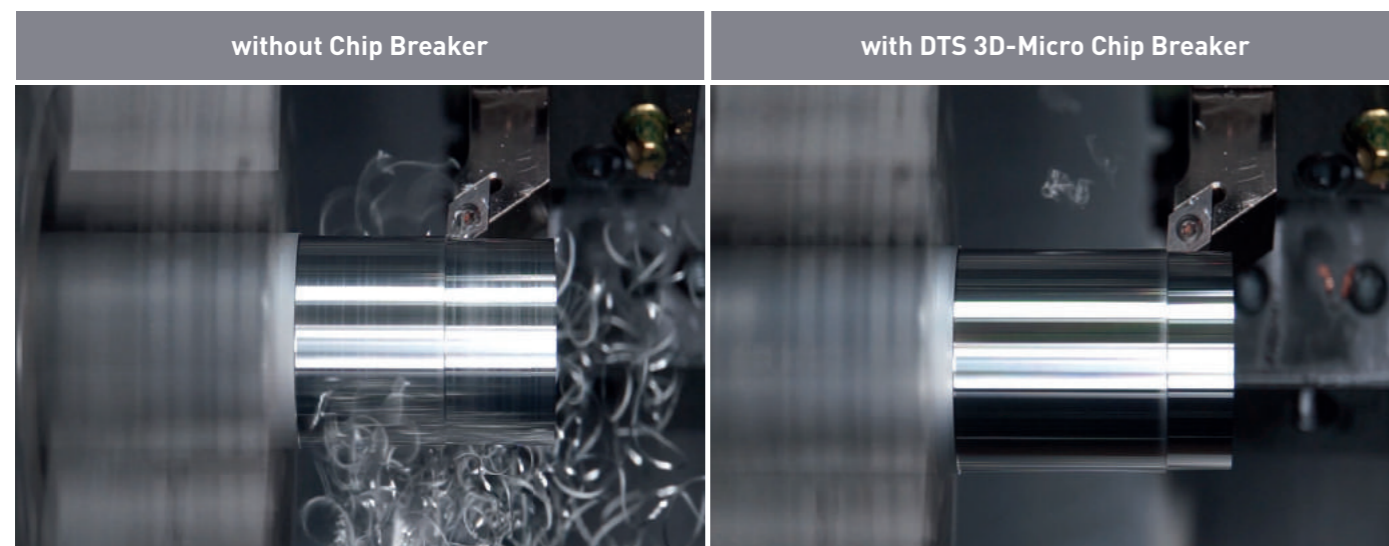

Material: AlSi1

Material: AlSi1

Wiper Cutting Inserts

Functionality

Wiper Cutting Inserts:

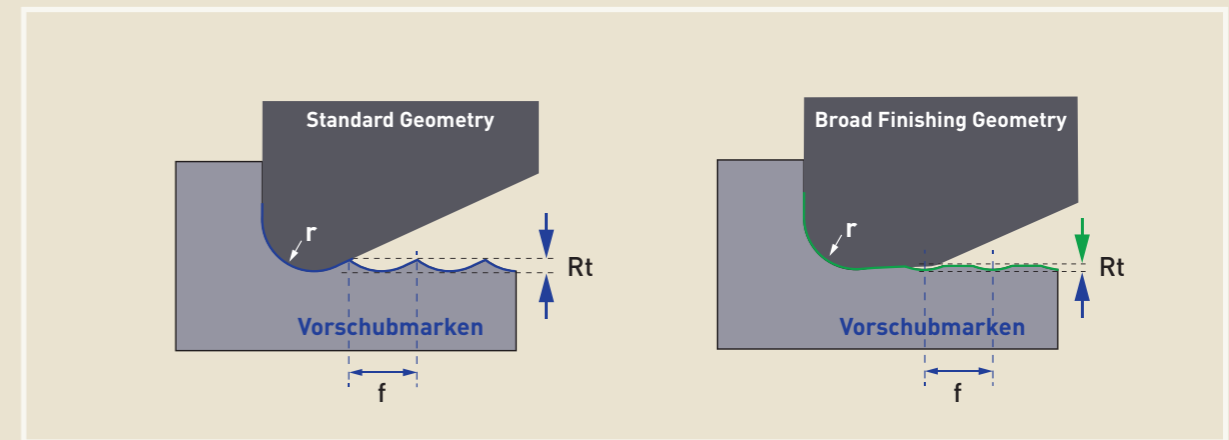

Advantages when using Wiper Geometries

By using the same feed rate a 2-4 times better surface quality can be obtained or with a 2-4 times higher feed rate the same surface quality can be reached.

To get the wiper Geometry into cutting condition please use the following lead angles at the machine:

C and W Type: 95°

D Type: 93°

CCGW ...
(Z1)

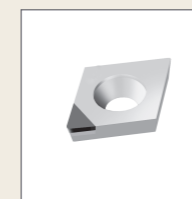

Page 16

DCGW ...
(Z1)

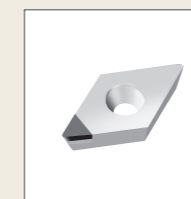

Page 27 to Face Turning
Page 28 to Side Turning

WCGW ...
(Z3)

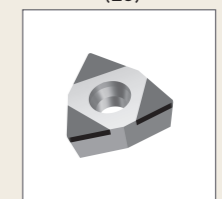

Application examples

our Cutting in use

Not just theory - we would like to show you our tools in action. On this page you will find a selection of our Diamond application videos. Click on the QR code to get more information about the video.

Also visit our YouTube Channel at dts-gmbh!

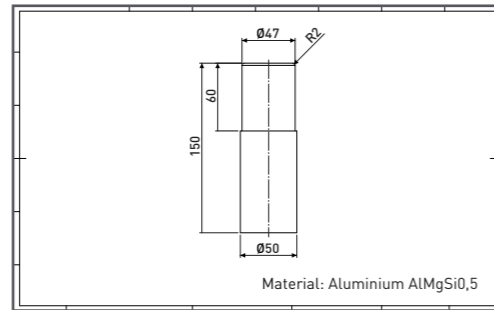
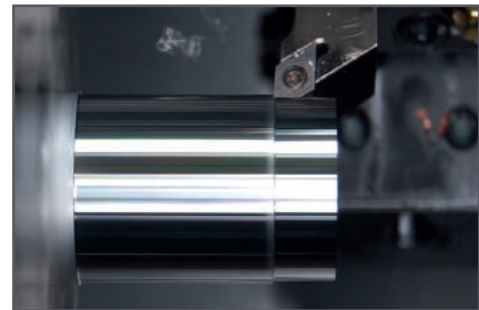

Spanbruch
Aluminium AlMgSi0,5
DCGW 11T304 PCD

Click here for the video!

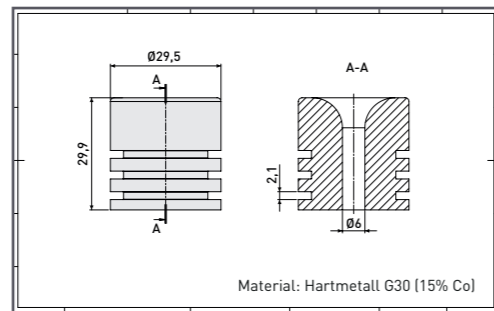

Carbide G30
DCGW 11T304 CVD-D

Click here for the video!

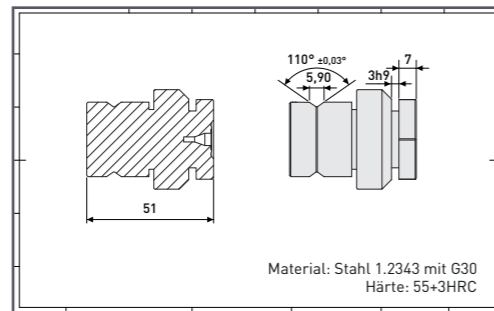
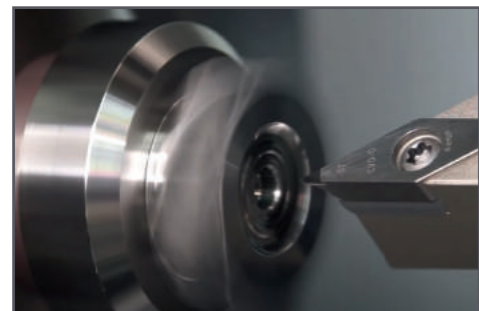

Carbide G30
VXGW 160402 CVD-D

Click here for the video!

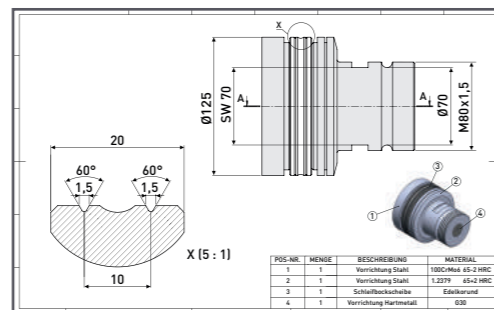

Edelmetall (80)
VCGW 160404 CVD-D

Click here for the video!

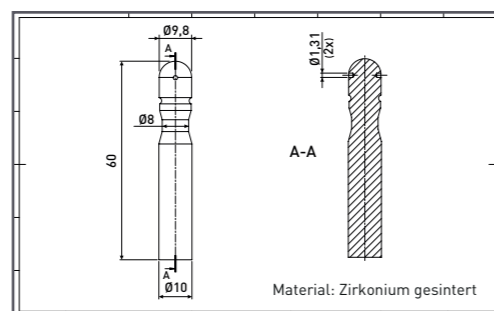

Zirkonium gesintert
DCGW 11T304 UltraDiamond

Click here for the video!

ISO Code

Diamond Cutting Inserts

Shape

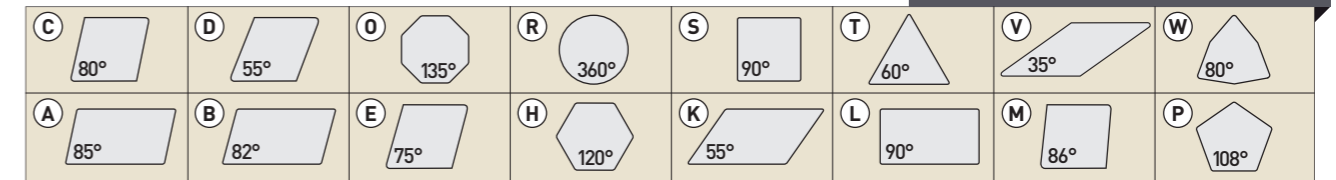

Clearance

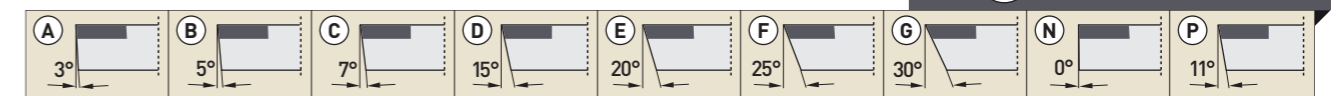

Tolerance [mm]

T N G A 16 04 08

	m	s	d		m	s	d
A	±0,005	±0,025	±0,025	J	±0,005	±0,025	±0,05 → ±0,15
F	±0,005	±0,025	±0,013	K	±0,013	±0,025	±0,05 → ±0,15
C	±0,013	±0,025	±0,025	L	±0,025	±0,025	±0,05 → ±0,15
H	±0,013	±0,025	±0,013	M	±0,08 → ±0,20	±0,130	±0,05 → ±0,15
E	±0,025	±0,025	±0,025	N	±0,08 → ±0,20	±0,25	±0,05 → ±0,15
G	±0,025	±0,130	±0,025	U	±0,13 → ±0,38	±0,130	±0,08 → ±0,15

*[M, N, U] The exact tolerance depends on the size of the insert.

Insert Type

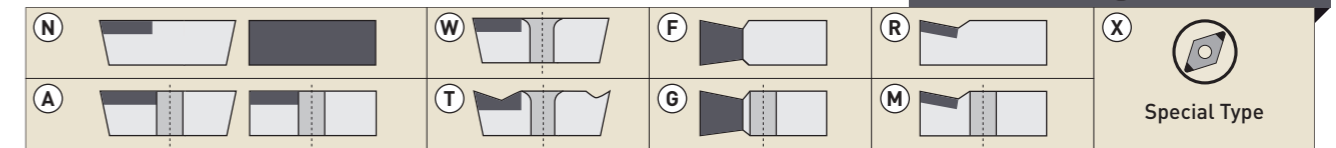

Insert size [mm]

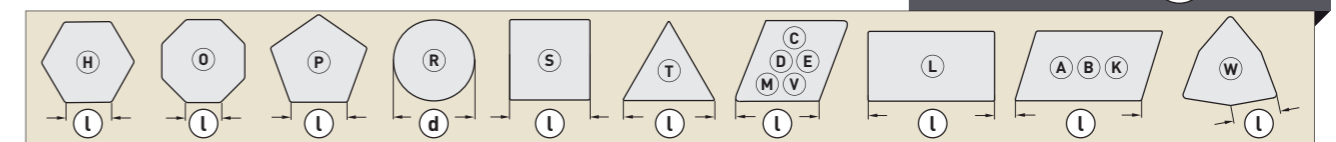

Insert size [mm]

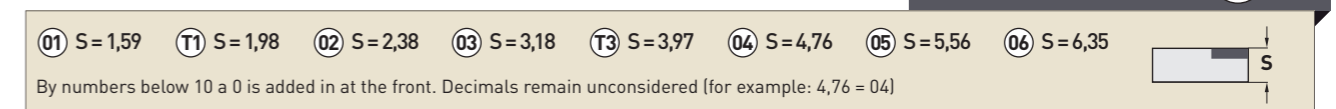

Corner configuration [mm]

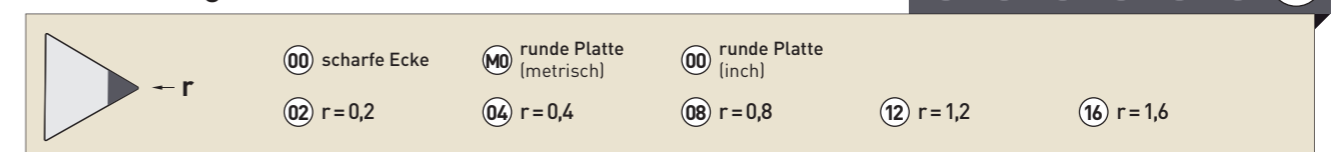

CCGT - Positive Rake Angle

edge tipped

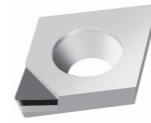

FN - Positive Rake Angle

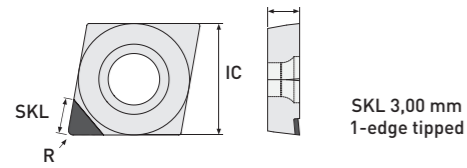

	ISO Code	IC	S	R	PKD Diamant	CVD-D Diamant	Ultra Diamant	Version
					Item No.	Item No.	Item No.	
Standard	CCGT 060202	6,35	2,38	0,20	DP1010-0001	DP2010-0001		1-edge tipped
	CCGT 060204	6,35	2,38	0,40	DP1010-0002	DP2010-0002		1-edge tipped
	CCGT 060208	6,35	2,38	0,80	DP1010-0003	DP2010-0003		1-edge tipped
	CCGT 09T302	9,525	3,97	0,20	DP1010-0004	DP2010-0004		1-edge tipped
	CCGT 09T304	9,525	3,97	0,40	DP1010-0005	DP2010-0005		1-edge tipped
	CCGT 09T308	9,525	3,97	0,80	DP1010-0006	DP2010-0006		1-edge tipped
	CCGT 09T312	9,525	3,97	1,20	DP1010-0007	DP2010-0007		1-edge tipped
	CCGT 120402	12,70	4,76	0,20	DP1010-0008	DP2010-0008		1-edge tipped
	CCGT 120404	12,70	4,76	0,40	DP1010-0009	DP2010-0009		1-edge tipped
	CCGT 120408	12,70	4,76	0,80	DP1010-0010	DP2010-0010		1-edge tipped

CCGT - Chip Breaker

edge tipped



FN - Chip breaker for finishing (SPL-F) or roughing (SPL-R)

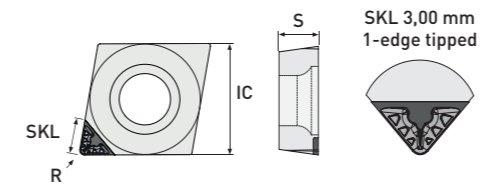

	ISO Code	IC	S	R	PKD Diamant	PKD Diamant	Version
					Item No.	Item No.	
					SPL-F (Finishing)	SPL-R (Roughing)	
Standard	CCGT 060202	6,35	2,38	0,20	DP1011-0001	DP1012-0001	1-edge tipped
	CCGT 060204	6,35	2,38	0,40	DP1011-0002	DP1012-0002	1-edge tipped
	CCGT 060208	6,35	2,38	0,80	DP1011-0003	DP1012-0003	1-edge tipped
	CCGT 09T302	9,525	3,97	0,20	DP1011-0004	DP1012-0004	1-edge tipped
	CCGT 09T304	9,525	3,97	0,40	DP1011-0005	DP1012-0005	1-edge tipped
	CCGT 09T308	9,525	3,97	0,80	DP1011-0006	DP1012-0006	1-edge tipped
	CCGT 120402	12,70	4,76	0,20	DP1011-0458	DP1012-0458	1-edge tipped
	CCGT 120404	12,70	4,76	0,40	DP1011-0008	DP1012-0008	1-edge tipped
	CCGT 120408	12,70	4,76	0,80	DP1011-0009	DP1012-0009	1-edge tipped
Wiper	CCGT 060202 R/L-W	6,35	2,38	0,20	DP1011-0011	DP1012-0011	1-edge tipped
	CCGT 060204 R/L-W	6,35	2,38	0,40	DP1011-0012	DP1012-0012	1-edge tipped
	CCGT 09T302 R/L-W	9,525	3,97	0,20	DP1011-0014	DP1012-0014	1-edge tipped
	CCGT 09T304 R/L-W	9,525	3,97	0,40	DP1011-0015	DP1012-0015	1-edge tipped
	CCGT 09T308 R/L-W	9,525	3,97	0,80	DP1011-0016	DP1012-0016	1-edge tipped
	CCGT 120402 R/L-W	12,70	4,76	0,20	DP1011-0018	DP1012-0018	1-edge tipped
	CCGT 120404 R/L-W	12,70	4,76	0,40	DP1011-0019	DP1012-0019	1-edge tipped
	CCGT 120408 R/L-W	12,70	4,76	0,80	DP1011-0020	DP1012-0020	1-edge tipped

Also available in CVD and CBN with Chip breaker on request.

Application range:

- PCD** Aluminium <10% Si, Graphit grobkörnig, Brass, Brass bleifrei, Titanium (Schruppen) ...
- CVD-D** Acrylic, Aluminum >10% Si, Carbide, Ceramics, Composites (CFRP, GFRP, MMC), Copper, Plastics, PEEK, Titanium (Finishing) ...
- UltraDia.** Glass Materials, Sintered Ceramic Materials, Carbides <12%Co, Carbides with Ni Binder, highly abrasive, difficult-to-machine materials ...

You will find further application ranges in the detailed overview on page 7.



Special tools on request for you!
Please send inquiries to info@Diamond-toolingsystems.com



All our products are also available in the online shop.
Visit us at Diamond-tools24.com



Scan me!

Subject to technical changes.

CCGT - Positive Rake Angle

entire edge



right version - Positive Rake Angle

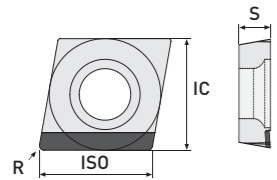

Figure shows right version entire edge

	ISO Code	IC	S	R	Diamant			Version
					PKD Item No.	CVD-D Item No.	Ultra Item No.	
Standard - right Version	CCGT 060202 R-GS	6,35	2,38	0,20	DP1020-0055	DP2020-0055		entire edge
	CCGT 060204 R-GS	6,35	2,38	0,40	DP1020-0001	DP2020-0001		entire edge
	CCGT 060208 R-GS	6,35	2,38	0,80	DP1020-0002	DP2020-0002		entire edge
	CCGT 09T304 R-GS	9,525	3,97	0,40	DP1020-0056	DP2020-0056		entire edge
	CCGT 09T308 R-GS	9,525	3,97	0,80	DP1020-0003	DP2020-0003		entire edge
	CCGT 09T312 R-GS	9,525	3,97	1,20	DP1020-0004	DP2020-0004		entire edge
	CCGT 120404 R-GS	12,70	4,76	0,40	DP1020-0057	DP2020-0057		entire edge
	CCGT 120408 R-GS	12,70	4,76	0,80	DP1020-0005	DP2020-0005		entire edge

left version - Positive Rake Angle

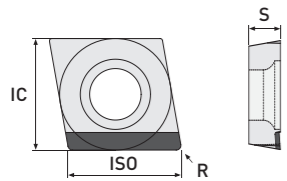

Figure shows left version entire edge

	ISO Code	IC	S	R	Diamant			Version
					PKD Item No.	CVD-D Item No.	Ultra Item No.	
Standard - left Version	CCGT 060202 L-GS	6,35	2,38	0,20	DP1020-0058	DP2020-0058		entire edge
	CCGT 060204 L-GS	6,35	2,38	0,40	DP1020-0045	DP2020-0045		entire edge
	CCGT 060208 L-GS	6,35	2,38	0,80	DP1020-0046	DP2020-0046		entire edge
	CCGT 09T304 L-GS	9,525	3,97	0,40	DP1020-0059	DP2020-0059		entire edge
	CCGT 09T308 L-GS	9,525	3,97	0,80	DP1020-0047	DP2020-0047		entire edge
	CCGT 09T312 L-GS	9,525	3,97	1,20	DP1020-0048	DP2020-0048		entire edge
	CCGT 120404 L-GS	12,70	4,76	0,40	DP1020-0060	DP2020-0060		entire edge
	CCGT 120408 L-GS	12,70	4,76	0,80	DP1020-0049	DP2020-0049		entire edge

Application range:

- PCD** Aluminum <10% Si, Brass, Brass lead-free, Graphite coarse-grained, Titanium (Roughing) ...
- CVD-D** Acrylic, Aluminum >10% Si, Carbide, Ceramics, Composites (CFRP, GFRP, MMC), Copper, Plastics, PEEK, Titanium (Finishing) ...
- UltraDia.** Glass Materials, Sintered Ceramic Materials, Carbides <12%Co, Carbides with Ni Binder, highly abrasive, difficult-to-machine materials ...

You will find further application ranges in the detailed overview on page 7.

CCGT - Chip Breaker

entire edge

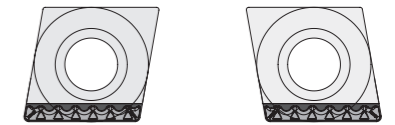

right version - Chip breaker for finishing (SPL-F) or roughing (SPL-R)

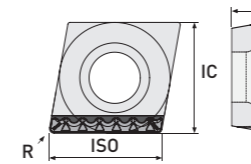

Figure shows right version entire edge

	ISO Code	IC	S	R	PKD Diamant		Version
					SPL-F (Finishing) Item No.	SPL-R (Roughing) Item No.	
Standard - right Version	CCGT 060202 R-GS	6,35	2,38	0,20	DP1021-0032	DP1022-0032	entire edge
	CCGT 060204 R-GS	6,35	2,38	0,40	DP1021-0001	DP1022-0001	entire edge
	CCGT 060208 R-GS	6,35	2,38	0,80	DP1021-0002	DP1022-0002	entire edge
	CCGT 09T304 R-GS	9,525	3,97	0,40	DP1021-0033	DP1022-0033	entire edge
	CCGT 09T308 R-GS	9,525	3,97	0,80	DP1021-0003	DP1022-0003	entire edge
	CCGT 120404 R-GS	12,70	4,76	0,40	DP1021-0034	DP1022-0034	entire edge
	CCGT 120408 R-GS	12,70	4,76	0,80	DP1021-0005	DP1022-0005	entire edge

Also available in CVD and CBN with Chip breaker on request.

left version - Chip breaker for finishing (SPL-F) or roughing (SPL-R)

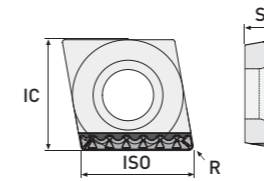

Figure shows left version entire edge

	ISO Code	IC	S	R	PKD Diamant		Version
					SPL-F (Finishing) Item No.	SPL-R (Roughing) Item No.	
Standard - left Version	CCGT 060202 L-GS	6,35	2,38	0,20	DP1021-0035	DP1022-0035	entire edge
	CCGT 060204 L-GS	6,35	2,38	0,40	DP1021-0031	DP1022-0031	entire edge
	CCGT 060208 L-GS	6,35	2,38	0,80	DP1021-0027	DP1022-0027	entire edge
	CCGT 09T304 L-GS	9,525	3,97	0,40	DP1021-0036	DP1022-0036	entire edge
	CCGT 09T308 L-GS	9,525	3,97	0,80	DP1021-0028	DP1022-0028	entire edge
	CCGT 120404 L-GS	12,70	4,76	0,40	DP1021-0037	DP1022-0037	entire edge
	CCGT 120408 L-GS	12,70	4,76	0,80	DP1021-0030	DP1022-0030	entire edge

Also available in CVD and CBN with Chip breaker on request.



Special tools on request for you!
Please send inquiries to info@diamond-toolingsystems.com



All our products are also available in the online shop.
Visit us at Diamond-tools24.com



Scan me!

Subject to technical changes.

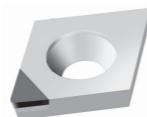

FN - neutral

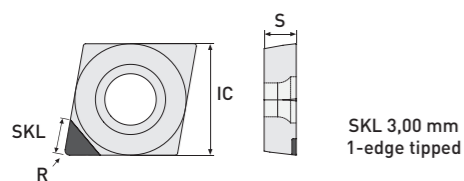

	ISO Code	IC	S	R	PKD Diamant	CVD-D Diamant	Ultra Diamant	Version
					Item No.	Item No.	Item No.	
Standard	CCGW 060201	6,35	2,38	0,10		DP2010-0591	DP1110-0591	1-edge tipped
	CCGW 060202	6,35	2,38	0,20	DP1010-0021	DP2010-0021	DP1110-0021	1-edge tipped
	CCGW 060204	6,35	2,38	0,40	DP1010-0022	DP2010-0022	DP1110-0022	1-edge tipped
	CCGW 060208	6,35	2,38	0,80	DP1010-0023	DP2010-0023	DP1110-0023	1-edge tipped
	CCGW 09T302	9,525	3,97	0,20	DP1010-0024	DP2010-0024		1-edge tipped
	CCGW 09T304	9,525	3,97	0,40	DP1010-0025	DP2010-0025		1-edge tipped
	CCGW 09T308	9,525	3,97	0,80	DP1010-0026	DP2010-0026		1-edge tipped
	CCGW 09T312	9,525	3,97	1,20	DP1010-0027	DP2010-0027		1-edge tipped
	CCGW 120402	12,70	4,76	0,20	DP1010-0700	DP2010-0129		1-edge tipped
	CCGW 120404	12,70	4,76	0,40	DP1010-0028	DP2010-0028		1-edge tipped
	CCGW 120408	12,70	4,76	0,80	DP1010-0029	DP2010-0029		1-edge tipped
	CCGW 120412	12,70	4,76	1,20	DP1010-0030	DP2010-0030		1-edge tipped
	Wiper	CCGW 060202 R/L-W	6,35	2,38	0,20	DP1010-0031	DP2010-0031	
CCGW 060204 R/L-W		6,35	2,38	0,40	DP1010-0032	DP2010-0032		1-edge tipped
CCGW 09T302 R/L-W		9,525	3,97	0,20	DP1010-0034	DP2010-0034		1-edge tipped
CCGW 09T304 R/L-W		9,525	3,97	0,40	DP1010-0035	DP2010-0035		1-edge tipped
CCGW 09T308 R/L-W		9,525	3,97	0,80	DP1010-0036	DP1010-0036		1-edge tipped
CCGW 120402 R/L-W		12,70	4,76	0,20	DP1010-0038	DP2010-0038		1-edge tipped
CCGW120404 R/L-W		12,70	4,76	0,40	DP1010-0039	DP2010-0039		1-edge tipped
CCGW 120408 R/L-W	12,70	4,76	0,80	DP1010-0040	DP2010-0040		1-edge tipped	



right version - neutral

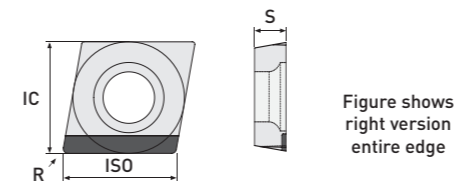

	ISO Code	IC	S	R	PKD Diamant	CVD-D Diamant	Ultra Diamant	Version
					Item No.	Item No.	Item No.	
Standard - right Version	CCGW 060202 R-GS	6,35	2,38	0,20	DP1020-0061	DP2020-0061		entire edge
	CCGW 060204 R-GS	6,35	2,38	0,40	DP1020-0006	DP2020-0006		entire edge
	CCGW 060208 R-GS	6,35	2,38	0,80	DP1020-0007	DP2020-0007		entire edge
	CCGW 09T304 R-GS	9,525	3,97	0,40	DP1020-0062	DP2020-0062		entire edge
	CCGW 09T308 R-GS	9,525	3,97	0,80	DP1020-0008	DP2020-0008		entire edge
	CCGW 09T312 R-GS	9,525	3,97	1,20	DP1020-0009	DP2020-0009		entire edge
	CCGW 120404 R-GS	12,70	4,76	0,40	DP1020-0063	DP2020-0063		entire edge
	CCGW 120408 R-GS	12,70	4,76	0,80	DP1020-0010	DP2020-0010		entire edge

left version - neutral

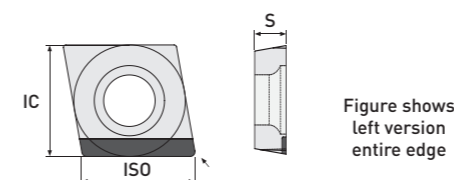

	ISO Code	IC	S	R	PKD Diamant	CVD-D Diamant	Ultra Diamant	Version
					Item No.	Item No.	Item No.	
Standard - Left Version	CCGW 060202 L-GS	6,35	2,38	0,20	DP1020-0064	DP2020-0064		entire edge
	CCGW 060204 L-GS	6,35	2,38	0,40	DP1020-0050	DP2020-0050		entire edge
	CCGW 060208 L-GS	6,35	2,38	0,80	DP1020-0051	DP2020-0051		entire edge
	CCGW 09T304 L-GS	9,525	3,97	0,40	DP1020-0065	DP2020-0065		entire edge
	CCGW 09T308 L-GS	9,525	3,97	0,80	DP1020-0052	DP2020-0052		entire edge
	CCGW 09T312 L-GS	9,525	3,97	1,20	DP1020-0053	DP2020-0053		entire edge
	CCGW 120404 L-GS	12,70	4,76	0,40	DP1020-0066	DP2020-0066		entire edge
	CCGW 120408 L-GS	12,70	4,76	0,80	DP1020-0054	DP2020-0054		entire edge

Application range:

- PCD Aluminum <10% Si, Brass, Brass lead-free, Graphite coarse-grained, Titanium (Roughing) ...
- CVD-D Acrylic, Aluminum >10% Si, Carbide, Ceramics, Composites (CFRP, GFRP, MMC), Copper, Plastics, PEEK, Titanium (Finishing) ...
- UltraDia. Glass Materials, Sintered Ceramic Materials, Carbides <12%Co, Carbides with Ni Binder, highly abrasive, difficult-to-machine materials ...

You will find further application ranges in the detailed overview on page 7.



Special tools on request for you!
Please send inquiries to info@Diamond-toolingsystems.com



All our products are also available in the online shop.
Visit us at Diamond-tools24.com



Scan me!

Subject to technical changes.

CDGW

FullFace | edge tipped



FullFace | right and left Version

	ISO Code	IC	S	R	PKD Diamant	CVD-D Diamant	Ultra Diamant	Version	
					Item No.	Item No.	Item No.		
MiniTools Right	CDGW 03X101-R	3,20	0,63	0,10		DP2030-0500		FullFace (Z1)	
	CDGW 03X102-R	3,20	0,63	0,20		DP2030-0502		FullFace (Z1)	
	Left	CDGW 03X101-L	3,20	0,63	0,10		DP2030-0501		FullFace (Z1)
		CDGW 03X102-L	3,20	0,63	0,20		DP2030-0503		FullFace (Z1)

! You will find the matching MiniTool holder in our boring bar catalog [03] on page 21.

FN - neutral

	ISO Code	IC	S	R	PKD Diamant	CVD-D Diamant	Ultra Diamant	Version
					Item No.	Item No.	Item No.	
MiniTools	CDGW 040101	3,97	1,00	0,10		DP2010-0511	DP1110-1480	2-edge tipped
	CDGW 040102	3,97	1,00	0,20		DP2010-0512	DP1110-1482	2-edge tipped
	CDGW 040104	3,97	1,00	0,40		DP2010-0513	DP1110-1484	2-edge tipped

! You will find the matching MiniTool holder in our boring bar catalog [03] on page 22.

Application range:

- PCD Aluminum <10% Si, Brass, Brass lead-free, Graphite coarse-grained, Titanium (Roughing) ...
- CVD-D Acrylic, Aluminum >10% Si, Carbide, Ceramics, Composites (CFRP, GFRP, MMC), Copper, Plastics, PEEK, Titanium (Finishing) ...
- UltraDia. Glass Materials, Sintered Ceramic Materials, Carbides <12%Co, Carbides with Ni Binder, highly abrasive, difficult-to-machine materials ...

You will find further application ranges in the detailed overview on page 7.

CNGA

edge tipped

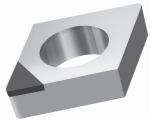

FN - neutral

	ISO Code	IC	S	R	PKD Diamant	CVD-D Diamant	Ultra Diamant	Version
					Item No.	Item No.	Item No.	
Standard	CNGA 120404	12,70	4,76	0,40		DP2010-0173		1-edge tipped
	CNGA 120408	12,70	4,76	0,80		DP2010-0174		1-edge tipped
	CNGA 120412	12,70	4,76	1,20		DP2010-0175		1-edge tipped

Subject to technical changes.



Special tools on request for you!
Please send inquiries to info@Diamond-toolingsystems.com



All our products are also available in the online shop.
Visit us at Diamond-tools24.com



Scan me!

CPGT - Positive Rake Angle

edge tipped

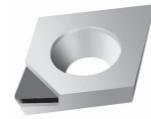

FN - Positive Rake Angle

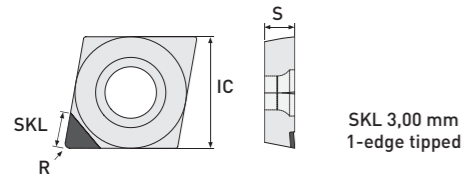

	ISO Code	IC	S	R	PKD Diamant	CVD-D Diamant	Ultra Diamant	Version
					Item No.	Item No.	Item No.	
Standard	CPGT 060202	6,35	2,38	0,20	DP1010-0201	DP2010-0201		1-edge tipped
	CPGT 060204	6,35	2,38	0,40	DP1010-0202	DP2010-0202		1-edge tipped
	CPGT 060208	6,35	2,38	0,80	DP1010-0203	DP2010-0203		1-edge tipped

CPGT - Chip Breaker

edge tipped



FN - neutral - Chip breaker for finishing (SPL-F) or roughing (SPL-R)

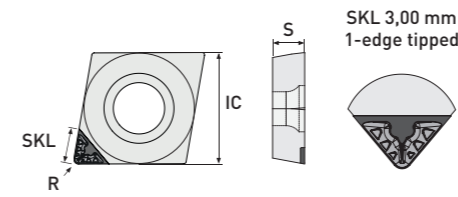

	ISO Code	IC	S	R	PKD Diamant	PKD Diamant	Version
					Item No.	Item No.	
					SPL-F (Finishing)	SPL-R (Roughing)	
Standard	CPGT 060202	6,35	2,38	0,20	DP1011-0251	DP1012-0251	1-edge tipped
	CPGT 060204	6,35	2,38	0,40	DP1011-0252	DP1012-0252	1-edge tipped
	CPGT 060208	6,35	2,38	0,80	DP1011-0253	DP1012-0253	1-edge tipped
	CPGT 09T302	9,525	3,97	0,20	DP1011-0254	DP1012-0254	1-edge tipped
	CPGT 09T304	9,525	3,97	0,40	DP1011-0255	DP1012-0255	1-edge tipped
	CPGT 09T308	9,525	3,97	0,80	DP1011-0256	DP1012-0256	1-edge tipped
	CPGT 120404	12,70	4,76	0,40	DP1011-0257	DP1012-0257	1-edge tipped
	CPGT 120408	12,70	4,76	0,80	DP1011-0258	DP1012-0258	1-edge tipped

Also available in CVD and CBN with Chip breaker on request.

Application range:

- PCD Aluminum <10% Si, Brass, Brass lead-free, Graphite coarse-grained, Titanium (Roughing) ...
- CVD-D Acrylic, Aluminum >10% Si, Carbide, Ceramics, Composites (CFRP, GFRP, MMC), Copper, Plastics, PEEK, Titanium (Finishing) ...
- UltraDia. Glass Materials, Sintered Ceramic Materials, Carbides <12%Co, Carbides with Ni Binder, highly abrasive, difficult-to-machine materials ...

You will find further application ranges in the detailed overview on page 7.



Special tools on request for you!
Please send inquiries to info@Diamond-toolingsystems.com



All our products are also available in the online shop.
Visit us at Diamond-tools24.com



Scan me!

Subject to technical changes.

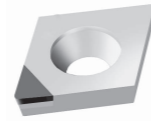

FN - neutral

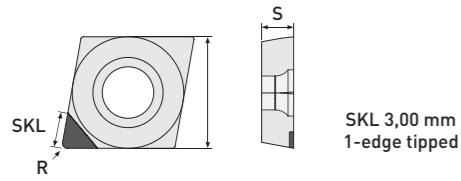

SKL 3,00 mm
1-edge tipped



	ISO Code	IC	S	R	PKD	CVD-D	Ultra	Version
					Item No.	Item No.	Item No.	
Standard	CPGW 060201	6,35	2,38	0,10		DP2010-0595		1-edge tipped
	CPGW 060202	6,35	2,38	0,20	DP1010-0251	DP2010-0251		1-edge tipped
	CPGW 060204	6,35	2,38	0,40	DP1010-0252	DP2010-0252		1-edge tipped
	CPGW 060208	6,35	2,38	0,80	DP1010-0253	DP2010-0253		1-edge tipped
	CPGW 09T301	9,525	3,97	0,10		DP2010-0596		1-edge tipped
	CPGW 09T302	9,525	3,97	0,20	DP1010-0254	DP2010-0254		1-edge tipped
	CPGW 09T304	9,525	3,97	0,40	DP1010-0255	DP2010-0255		1-edge tipped
	CPGW 09T308	9,525	3,97	0,80	DP1010-0256	DP2010-0256		1-edge tipped
	CPGW 120404	12,70	4,76	0,40	DP1010-0257	DP2010-0257		1-edge tipped
	CPGW 120408	12,70	4,76	0,80	DP1010-0258	DP2010-0258		1-edge tipped
	CPGW 120412	12,70	4,76	1,20	DP1010-0259	DP2010-0259		1-edge tipped

Application range:

- **PCD** Aluminum <10% Si, Brass, Brass lead-free, Graphite coarse-grained, Titanium (Roughing) ...
- **CVD-D** Acrylic, Aluminum >10% Si, Carbide, Ceramics, Composites (CFRP, GFRP, MMC), Copper, Plastics, PEEK, Titanium (Finishing) ...
- **UltraDia.** Glass Materials, Sintered Ceramic Materials, Carbides <12%Co, Carbides with Ni Binder, highly abrasive, difficult-to-machine materials ...

You will find further application ranges in the detailed overview on page 7.

Your Notes

DCGT - Positive Rake Angle

edge tipped

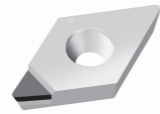

FN - Positive Rake Angle

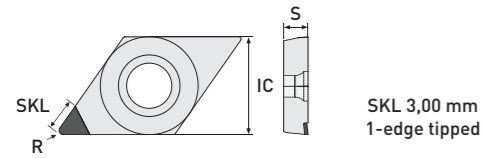

Standard	ISO Code	IC	S	R	PKD Diamant	CVD-D Diamant	Ultra Diamant	Version
					Item No.	Item No.	Item No.	
	DCGT 070201	6,35	2,38	0,10	DP1010-0601	DP2010-0601		1-edge tipped
	DCGT 070202	6,35	2,38	0,20	DP1010-0042	DP2010-0042		1-edge tipped
	DCGT 070204	6,35	2,38	0,40	DP1010-0043	DP2010-0043		1-edge tipped
	DCGT 070208	6,35	2,38	0,80	DP1010-0044	DP2010-0044		1-edge tipped
	DCGT 11T301	9,525	3,97	0,10	DP1010-0602	DP2010-0602		1-edge tipped
	DCGT 11T302	9,525	3,97	0,20	DP1010-0045	DP2010-0045		1-edge tipped
	DCGT 11T304	9,525	3,97	0,40	DP1010-0046	DP2010-0046		1-edge tipped
	DCGT 11T308	9,525	3,97	0,80	DP1010-0047	DP2010-0047		1-edge tipped
	DCGT 11T312	9,525	3,97	1,20	DP1010-0048	DP2010-0048		1-edge tipped

Application range:

- PCD** Aluminum <10% Si, Brass, Brass lead-free, Graphite coarse-grained, Titanium (Roughing) ...
- CVD-D** Acrylic, Aluminum >10% Si, Carbide, Ceramics, Composites (CFRP, GFRP, MMC), Copper, Plastics, PEEK, Titanium (Finishing) ...
- UltraDia.** Glass Materials, Sintered Ceramic Materials, Carbides <12%Co, Carbides with Ni Binder, highly abrasive, difficult-to-machine materials ...

You will find further application ranges in the detailed overview on page 7.

DCGT - Chip Breaker

edge tipped



FN - neutral - Chip breaker for finishing (SPL-F) or roughing (SPL-R)

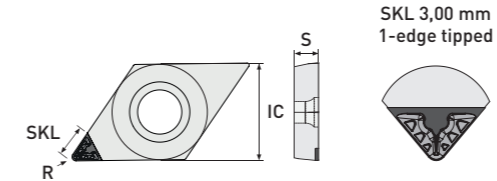

Standard	ISO Code	IC	S	R	PKD Diamant	PKD Diamant	Version
					Item No.	Item No.	
	DCGT 070202	6,35	2,38	0,20	DP1011-0022	DP1012-0022	1-edge tipped
	DCGT 070204	6,35	2,38	0,40	DP1011-0023	DP1012-0023	1-edge tipped
	DCGT 070208	6,35	2,38	0,80	DP1011-0024	DP1012-0024	1-edge tipped
	DCGT 11T302	9,525	3,97	0,20	DP1011-0025	DP1012-0025	1-edge tipped
	DCGT 11T304	9,525	3,97	0,40	DP1011-0026	DP1012-0026	1-edge tipped
	DCGT 11T308	9,525	3,97	0,80	DP1011-0027	DP1012-0027	1-edge tipped

Also available in CVD and CBN with Chip breaker on request.



Special tools on request for you!
Please send inquiries to info@Diamond-toolingsystems.com



All our products are also available in the online shop.
Visit us at Diamond-tools24.com



Scan me!

Subject to technical changes.

DCGW

edge tipped

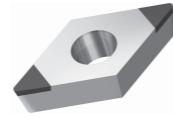

FN - neutral

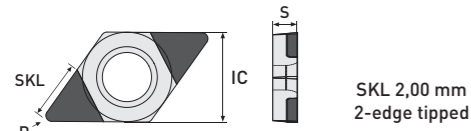

MiniTools	ISO Code	IC	S	R	Item No.	Item No.	Item No.	Version
	DCGW 04T001	3,10	1,20	0,10		DP2010-0521	DP1110-1492	
DCGW 04T002	3,10	1,20	0,20		DP2010-0522	DP1110-1494		2-edge tipped
DCGW 04T004	3,10	1,20	0,40		DP2010-0523	DP1110-1496		2-edge tipped

! You will find the matching MiniTool holder in our boring bar catalog [03] on page 24.

DCGW

edge tipped

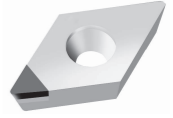

R/L - Wiper for face turning

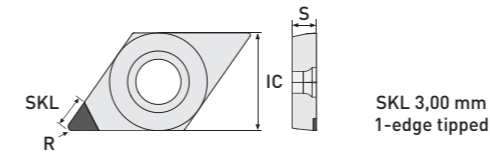

Standard	ISO Code	IC	S	R	Item No.	Item No.	Item No.	Version
	DCGW 070201	6,35	2,38	0,10		DP1010-0603	DP2010-0603	DP1110-0603
DCGW 070202	6,35	2,38	0,20		DP1010-0056	DP2010-0056	DP1110-0056	1-edge tipped
DCGW 070204	6,35	2,38	0,40		DP1010-0057	DP2010-0057	DP1110-0057	1-edge tipped
DCGW 070208	6,35	2,38	0,80		DP1010-0058	DP2010-0058	DP1110-0058	1-edge tipped
DCGW 11T301	9,525	3,97	0,10		DP1010-0604	DP2010-0604	DP1110-0604	1-edge tipped
DCGW 11T302	9,525	3,97	0,20		DP1010-0059	DP2010-0059	DP1110-0059	1-edge tipped
DCGW 11T304	9,525	3,97	0,40		DP1010-0060	DP2010-0060	DP1110-0060	1-edge tipped
DCGW 11T308	9,525	3,97	0,80		DP1010-0061	DP2010-0061	DP1110-0061	1-edge tipped
DCGW 11T312	9,525	3,97	1,20		DP1010-0062	DP2010-0062	DP1110-0062	1-edge tipped
DCGW 11T320	9,525	3,97	2,00				DP1110-0133	1-edge tipped

Wiper - to face	ISO Code	IC	S	R	Item No.	Item No.	Item No.	Version
	DCGW 070202 R/L W	6,35	2,38	0,20	DP1010-0063	DP2010-0063		1-edge tipped
	DCGW 070204 R/L W	6,35	2,38	0,40	DP1010-0064	DP2010-0064		1-edge tipped
	DCGW 070208 R/L W	6,35	2,38	0,80	DP1010-0128	DP2010-0130		1-edge tipped
	DCGW 11T302 R/L W	9,525	3,97	0,20	DP1010-0065	DP2010-0065		1-edge tipped
	DCGW 11T304 R/L W	9,525	3,97	0,40	DP1010-0066	DP2010-0066		1-edge tipped
DCGW 11T308 R/L W	9,525	3,97	0,80	DP1010-0129	DP2010-0131		1-edge tipped	

Picture shows face turning

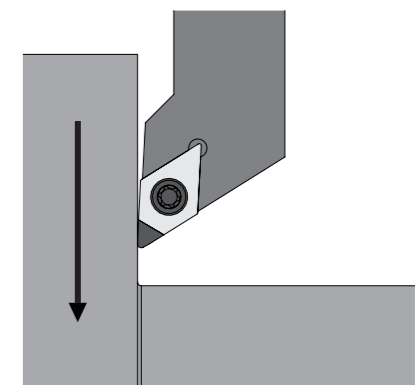

Application range:

- PCD Aluminum <10% Si, Brass, Brass lead-free, Graphite coarse-grained, Titanium (Roughing) ...
- CVD-D Acrylic, Aluminum >10% Si, Carbide, Ceramics, Composites (CFRP, GFRP, MMC), Copper, Plastics, PEEK, Titanium (Finishing) ...
- UltraDia. Glass Materials, Sintered Ceramic Materials, Carbides <12%Co, Carbides with Ni Binder, highly abrasive, difficult-to-machine materials ...

You will find further application ranges in the detailed overview on page 7.



Scan me!

DCGW - Wiper - FR/FL

zum Side Turning

FR (Right) and FL (Left) - Wiper - Side Turning

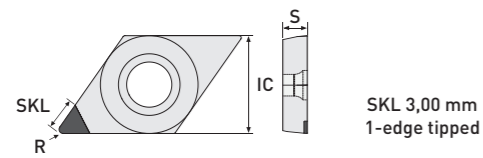

Wiper - Side Turning	ISO Code	IC	S	R	Item No.	Version
						Wiper
	DCGW 070202 FR-W	6,35	2,38	0,20	DP1019-0102	1-edge tipped
	DCGW 070202 FL-W	6,35	2,38	0,20	DP1019-0103	1-edge tipped
	DCGW 070204 FR-W	6,35	2,38	0,40	DP1019-0104	1-edge tipped
	DCGW 070204 FL-W	6,35	2,38	0,40	DP1019-0105	1-edge tipped
	DCGW 070208 FR-W	6,35	2,38	0,80	DP1019-0106	1-edge tipped
	DCGW 070208 FL-W	6,35	2,38	0,80	DP1019-0107	1-edge tipped
	DCGW 11T302 FR-W	9,525	3,97	0,20	DP1019-0112	1-edge tipped
	DCGW 11T302 FL-W	9,525	3,97	0,20	DP1019-0113	1-edge tipped
	DCGW 11T304 FR-W	9,525	3,97	0,40	DP1019-0114	1-edge tipped
	DCGW 11T304 FL-W	9,525	3,97	0,40	DP1019-0115	1-edge tipped
	DCGW 11T308 FR-W	9,525	3,97	0,80	DP1019-0116	1-edge tipped
	DCGW 11T308 FL-W	9,525	3,97	0,80	DP1019-0117	1-edge tipped

Picture shows Side Turning

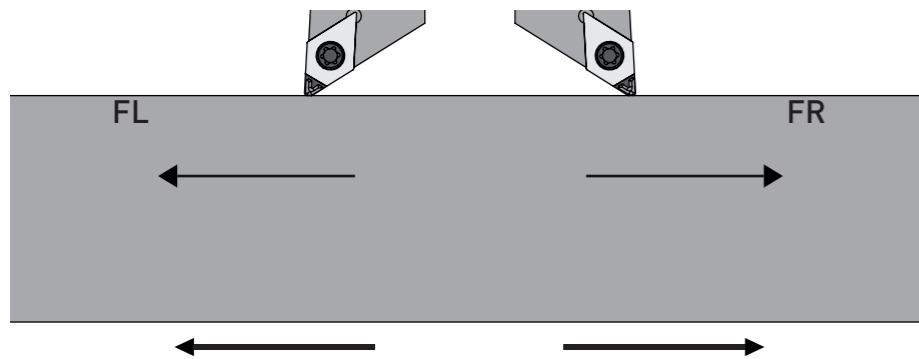

Application range:

- PCD** Aluminum <10% Si, Brass, Brass lead-free, Graphite coarse-grained, Titanium (Roughing) ...
- CVD-D** Acrylic, Aluminum >10% Si, Carbide, Ceramics, Composites (CFRP, GFRP, MMC), Copper, Plastics, PEEK, Titanium (Finishing) ...
- UltraDia.** Glass Materials, Sintered Ceramic Materials, Carbides <12%Co, Carbides with Ni Binder, highly abrasive, difficult-to-machine materials ...

You will find further application ranges in the detailed overview on page 7.

DCGT - Wiper with Chip Breaker - FR/FL

zum Side Turning

FR (Right) and FL (Left) - Wiper - Side Turning

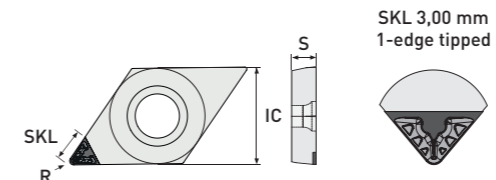

Wiper - Längsdrehens	ISO Code	IC	S	R	Item No.	Item No.	Version
					SPL-F (Finishing)	SPL-R (Roughing)	Version
	DCGT 070202 FR-W	6,35	2,38	0,20	DP1019-0122	DP1019-0142	1-edge tipped
	DCGT 070202 FL-W	6,35	2,38	0,20	DP1019-0123	DP1019-0143	1-edge tipped
	DCGT 070204 FR-W	6,35	2,38	0,40	DP1019-0124	DP1019-0144	1-edge tipped
	DCGT 070204 FL-W	6,35	2,38	0,40	DP1019-0125	DP1019-0145	1-edge tipped
	DCGT 070208 FR-W	6,35	2,38	0,80	DP1019-0126	DP1019-0146	1-edge tipped
	DCGT 070208 FL-W	6,35	2,38	0,80	DP1019-0127	DP1019-0147	1-edge tipped
	DCGT 11T302 FR-W	9,525	3,97	0,20	DP1019-0132	DP1019-0152	1-edge tipped
	DCGT 11T302 FL-W	9,525	3,97	0,20	DP1019-0133	DP1019-0153	1-edge tipped
	DCGT 11T304 FR-W	9,525	3,97	0,40	DP1019-0134	DP1019-0154	1-edge tipped
	DCGT 11T304 FL-W	9,525	3,97	0,40	DP1019-0135	DP1019-0155	1-edge tipped
	DCGT 11T308 FR-W	9,525	3,97	0,80	DP1019-0136	DP1019-0156	1-edge tipped
	DCGT 11T308 FL-W	9,525	3,97	0,80	DP1019-0137	DP1019-0157	1-edge tipped

Also available in CVD and CBN with Chip breaker on request.

Picture shows Side Turning

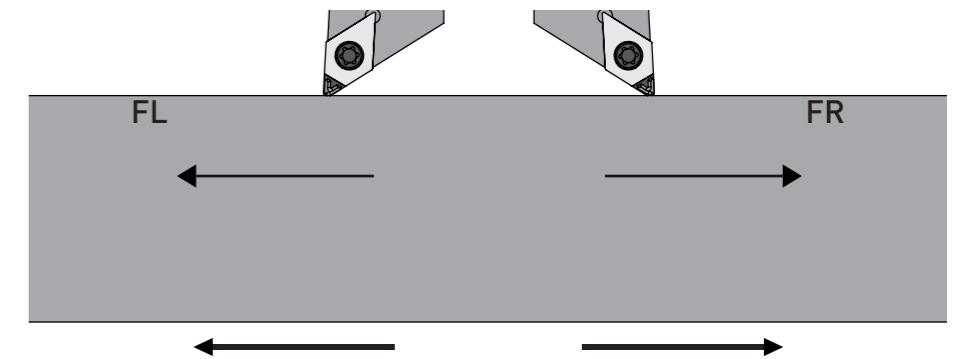

Special tools on request for you!
Please send inquiries to info@Diamond-toolingsystems.com



All our products are also available in the online shop.
Visit us at Diamond-tools24.com



Scan me!

Subject to technical changes.

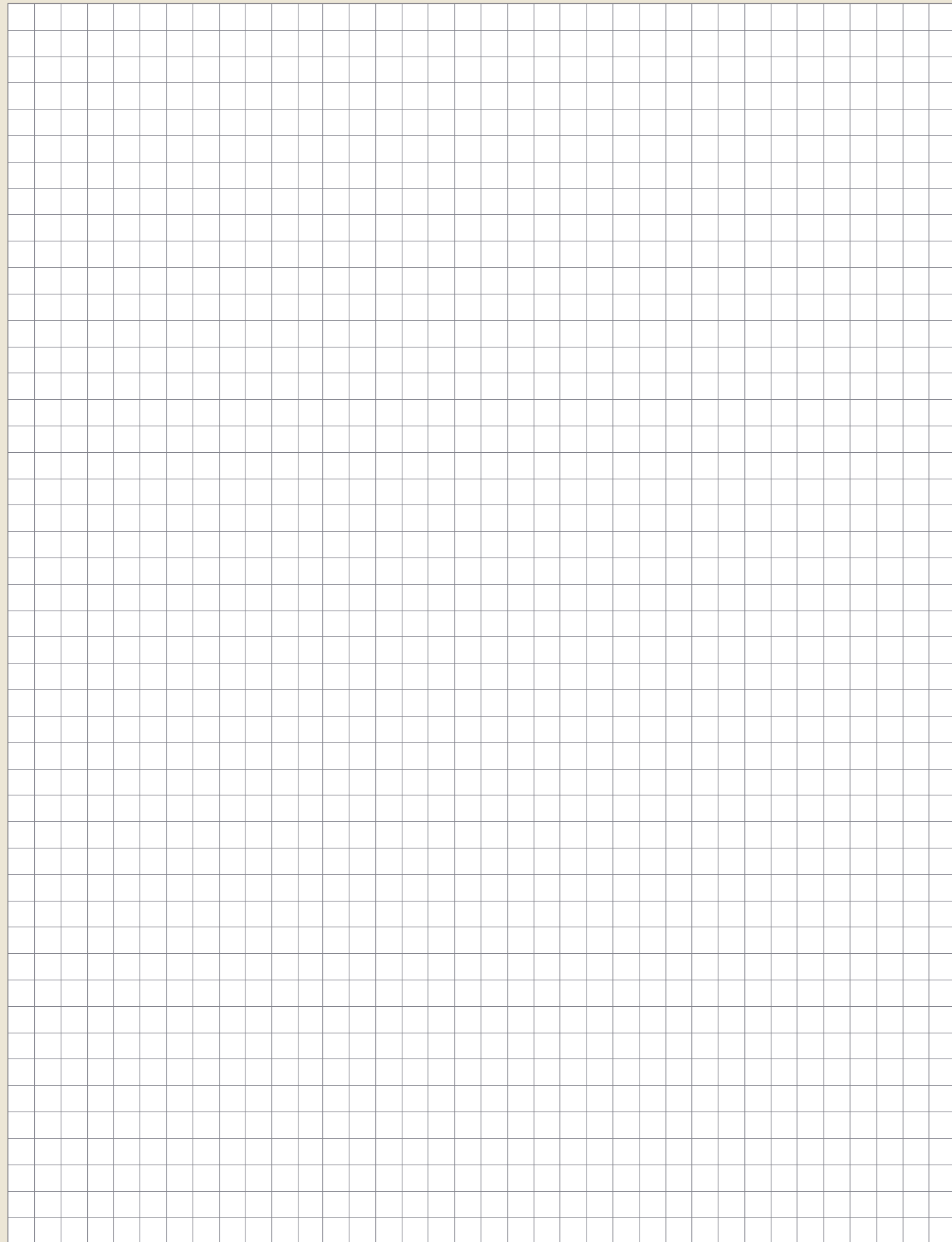

DNGA

edge tipped

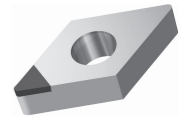

FN - neutral

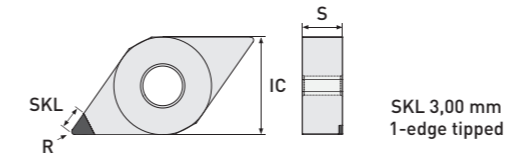

	ISO Code	IC	S	R	PKD Diamant	CVD-D Diamant	Ultra Diamant	Version
					Item No.	Item No.	Item No.	
Standard	DNGA 150602	12,70	6,35	0,20		DP2010-0282		1-edge tipped
	DNGA 150604	12,70	6,35	0,40		DP2010-0283		1-edge tipped
	DNGA 150608	12,70	6,35	0,80		DP2010-0284		1-edge tipped



Special tools on request for you!
Please send inquiries to info@Diamond-toolingsystems.com



All our products are also available in the online shop.
Visit us at Diamond-tools24.com



Scan me!

DXGW

edge tipped

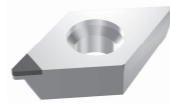

FN - neutral

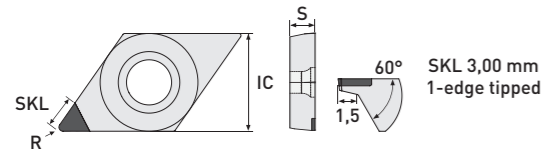

DTS - Specials	ISO Code	IC	S	R	PKD Diamant	CVD-D Diamant	Ultra Diamant	Version
					Item No.	Item No.	Item No.	
	DXGW 11T301	9,525	3,97	0,10		DP2010-0300		1-edge tipped
	DXGW 11T302	9,525	3,97	0,20		DP2010-0301		1-edge tipped
	DXGW 11T304	9,525	3,97	0,40		DP2010-0302		1-edge tipped
	DXGW 11T308	9,525	3,97	0,80		DP2010-0303		1-edge tipped

! The matching holders on request, available from stock.

DTS-Specials Face / Axial Machining:

Our DXGW cutting insert is designed for face and axial machining of contours from a minimum outside diameter of 10mm, using the maximum groove depth of 1.5mm.

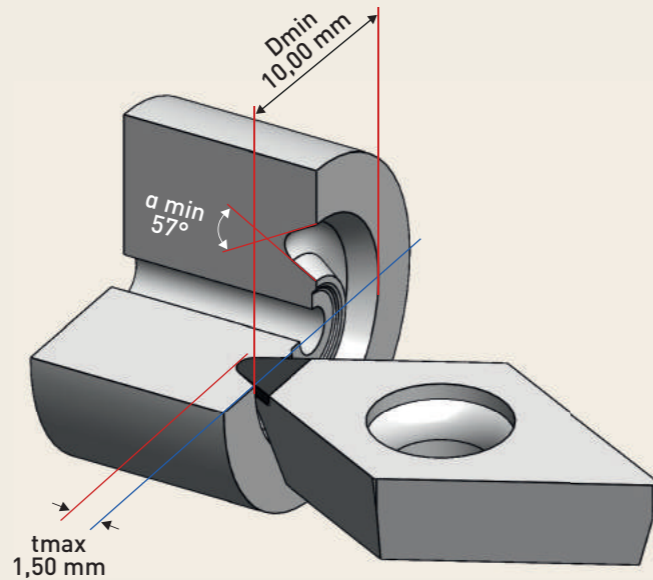

It is tipped with CVD-D as standard, but is of course also available with PCD or Ultra-Diamond on request.

Application range:

- PCD Aluminum <10% Si, Brass, Brass lead-free, Graphite coarse-grained, Titanium (Roughing) ...
- CVD-D Acrylic, Aluminum >10% Si, Carbide, Ceramics, Composites (CFRP, GFRP, MMC), Copper, Plastics, PEEK, Titanium (Finishing) ...
- UltraDia. Glass Materials, Sintered Ceramic Materials, Carbides <12%Co, Carbides with Ni Binder, highly abrasive, difficult-to-machine materials ...

You will find further application ranges in the detailed overview on page 7.

EPGW

edge tipped

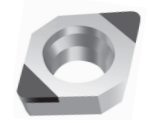

FN - neutral

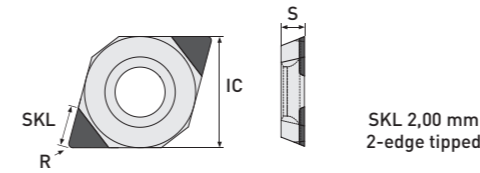

MiniTools	ISO Code	IC	S	R	PKD Diamant	CVD-D Diamant	Ultra Diamant	Version
					Item No.	Item No.	Item No.	
	EPGW 050201	5,56	2,38	0,10		DP2010-0531	DP1110-1400	2-edge tipped
	EPGW 050202	5,56	2,38	0,20		DP2010-0532	DP1110-1402	2-edge tipped
	EPGW 050204	5,56	2,38	0,40		DP2010-0533	DP1110-1404	2-edge tipped

! You will find the matching MiniTool holder in our boring bar catalog (03) on page 26.



Special tools on request for you!
Please send inquiries to info@Diamond-toolingsystems.com



All our products are also available in the online shop.
Visit us at Diamond-tools24.com



Scan me!

Subject to technical changes.

RBGN

FullFace

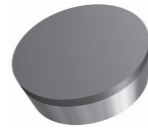

FN - FullFace

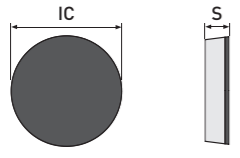

	FullFace			PKD Diamant	CVD-D Diamant	Ultra Diamant	Version	
	ISO Code	IC	S	R	Item No.	Item No.		Item No.
Standard	RBGN 0602M0 FF	6,00	2,38	-	DP1030-0090	DP2030-0090		FullFace
	RBGN 0803M0 FF	8,00	3,18	-	DP1030-0092	DP2030-0092		FullFace
	RBGN 1003M0 FF	10,00	3,18	-	DP1030-0094	DP2030-0094		FullFace
	RBGN 1203M0 FF	12,00	3,18	-	DP1030-0096	DP2030-0096		FullFace

Application range:

- PCD Aluminum <10% Si, Brass, Brass lead-free, Graphite coarse-grained, Titanium (Roughing) ...
- CVD-D Acrylic, Aluminum >10% Si, Carbide, Ceramics, Composites (CFRP, GFRP, MMC), Copper, Plastics, PEEK, Titanium (Finishing) ...
- UltraDia. Glass Materials, Sintered Ceramic Materials, Carbides <12%Co, Carbides with Ni Binder, highly abrasive, difficult-to-machine materials ...

You will find further application ranges in the detailed overview on page 7.

RCGW

FullFace

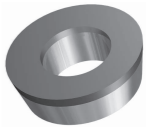

FN - FullFace

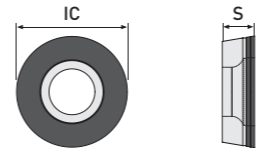

	FullFace			PKD Diamant	CVD-D Diamant	Ultra Diamant	Version	
	ISO Code	IC	S	R	Item No.	Item No.		Item No.
Standard	RCGW 0602M0 FF	6,00	2,38	-	DP1030-0001	DP2030-0001		FullFace
	RCGW 0803M0 FF	8,00	3,18	-	DP1030-0002	DP2030-0002		FullFace
	RCGW 1003M0 FF	10,00	3,18	-	DP1030-0003	DP2030-0003		FullFace
	RCGW 10T3M0 FF	10,00	3,97	-	DP1030-0004	DP2030-0004		FullFace
	RCGW 1204M0 FF	12,00	4,76	-	DP1030-0005	DP2030-0005		FullFace

! The matching MiniTool holders for plate size 06 can be found in our precision boring tools catalogue (03) on page 27.



Special tools on request for you!
Please send inquiries to info@Diamond-toolingsystems.com



All our products are also available in the online shop.
Visit us at Diamond-tools24.com



Scan me!

Subject to technical changes.

SCGT - Positive Rake Angle

edge tipped



FN - Positive Rake Angle

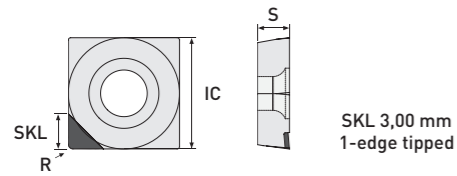

SKL 3,00 mm
1-edge tipped

	ISO Code	IC	S	R	Diamant			Version
					PKD	CVD-D	Ultra	
	Item No.	Item No.	Item No.					
Standard	SCGT 09T302	9,525	3,97	0,20	DP1010-0067	DP2010-0067		1-edge tipped
	SCGT 09T304	9,525	3,97	0,40	DP1010-0068	DP2010-0068		1-edge tipped
	SCGT 09T308	9,525	3,97	0,80	DP1010-0069	DP2010-0069		1-edge tipped
	SCGT 09T312	9,525	3,97	1,20	DP1010-0070	DP2010-0070		1-edge tipped
	SCGT 120404	12,70	4,76	0,40	DP1010-0130	DP2010-0132		1-edge tipped
	SCGT 120408	12,70	4,76	0,80	DP1010-0071	DP2010-0071		1-edge tipped
	SCGT 120412	12,70	4,76	1,20	DP1010-0072	DP2010-0072		1-edge tipped

SCGW

edge tipped

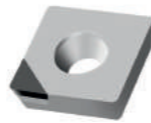

FN - neutral

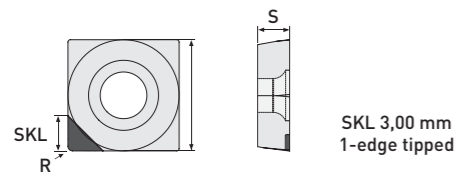

SKL 3,00 mm
1-edge tipped

	ISO Code	IC	S	R	Diamant			Version
					PKD	CVD-D	Ultra	
	Item No.	Item No.	Item No.					
Standard	SCGW 09T302	9,525	3,97	0,20	DP1010-0073	DP2010-0073		1-edge tipped
	SCGW 09T304	9,525	3,97	0,40	DP1010-0074	DP2010-0074		1-edge tipped
	SCGW 09T308	9,525	3,97	0,80	DP1010-0075	DP2010-0075		1-edge tipped
	SCGW 09T312	9,525	3,97	1,20	DP1010-0076	DP2010-0076		1-edge tipped
	SCGW 120404	12,70	4,76	0,40	DP1010-0077	DP2010-0077		1-edge tipped
	SCGW 120408	12,70	4,76	0,80	DP1010-0078	DP2010-0078		1-edge tipped
	SCGW 120412	12,70	4,76	1,20	DP1010-0079	DP2010-0079		1-edge tipped

Application range:

- PKD** Aluminum <10% Si, Brass, Brass lead-free, Graphite coarse-grained, Titanium (Roughing) ...
- CVD-D** Acrylic, Aluminum >10% Si, Carbide, Ceramics, Composites (CFRP, GFRP, MMC), Copper, Plastics, PEEK, Titanium (Finishing) ...
- UltraDia.** Glass Materials, Sintered Ceramic Materials, Carbides <12%Co, Carbides with Ni Binder, highly abrasive, difficult-to-machine materials ...

You will find further application ranges in the detailed overview on page 7.

SCGT - Positive Rake Angle

entire edge



FN - Positive Rake Angle

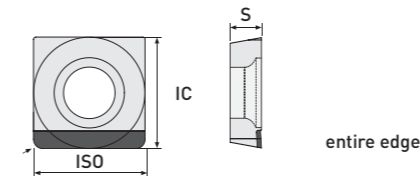

entire edge

	ISO Code	IC	S	R	Diamant			Version
					PKD	CVD-D	Ultra	
	Item No.	Item No.	Item No.					
Standard	SCGT 09T304 GS	9,525	3,97	0,40	DP1020-0067	DP2020-0067		entire edge
	SCGT 09T308 GS	9,525	3,97	0,80	DP1020-0011	DP2020-0011		entire edge
	SCGT 09T312 GS	9,525	3,97	1,20	DP1020-0012	DP2020-0012		entire edge
	SCGT 120404 GS	12,70	4,76	0,40	DP1020-0068	DP2020-0068		entire edge
	SCGT 120408 GS	12,70	4,76	0,80	DP1020-0013	DP2020-0013		entire edge
	SCGT 120412 GS	12,70	4,76	1,20	DP1020-0014	DP2020-0014		entire edge

SCGW

entire edge

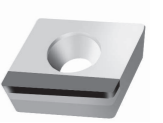

FN - neutral

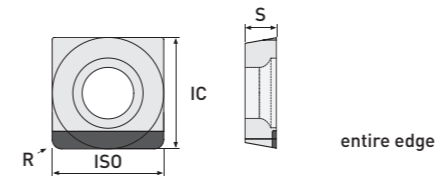

entire edge

	ISO Code	IC	S	R	Diamant			Version
					PKD	CVD-D	Ultra	
	Item No.	Item No.	Item No.					
Standard	SCGW 09T304 GS	9,525	3,97	0,40	DP1020-0015	DP2020-0015		entire edge
	SCGW 09T308 GS	9,525	3,97	0,80	DP1020-0016	DP2020-0016		entire edge
	SCGW 09T312 GS	9,525	3,97	1,20	DP1020-0017	DP2020-0017		entire edge
	SCGW 120404 GS	12,70	4,76	0,40	DP1020-0018	DP2020-0018		entire edge
	SCGW 120408 GS	12,70	4,76	0,80	DP1020-0019	DP2020-0019		entire edge
	SCGW 120412 GS	12,70	4,76	1,20	DP1020-0020	DP2020-0020		entire edge



Special tools on request for you!
Please send inquiries to info@Diamond-toolingsystems.com



All our products are also available in the online shop.
Visit us at Diamond-tools24.com



Scan me!

Subject to technical changes.

TCGT - Positive Rake Angle

edge tipped

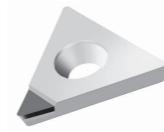

FN - Positive Rake Angle

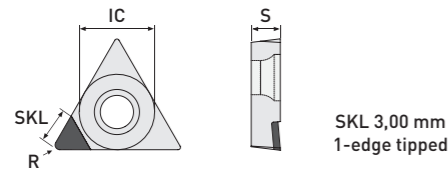

Standard	ISO Code	IC	S	R	SKL 3,00 mm 1-edge tipped			Version
					PKD Diamant Item No.	CVD-D Diamant Item No.	Ultra Diamant Item No.	
	TCGT 090202	5,56	2,38	0,20	DP1010-0080	DP2010-0080		1-edge tipped
	TCGT 090204	5,56	2,38	0,40	DP1010-0081	DP2010-0081		1-edge tipped
	TCGT 090208	5,56	2,38	0,80	DP1010-0082	DP2010-0082		1-edge tipped
	TCGT 110202	6,35	2,38	0,20	DP1010-0083	DP2010-0083		1-edge tipped
	TCGT 110204	6,35	2,38	0,40	DP1010-0084	DP2010-0084		1-edge tipped
	TCGT 110208	6,35	2,38	0,80	DP1010-0085	DP2010-0085		1-edge tipped
	TCGT 16T302	9,525	3,97	0,20	DP1010-0086	DP2010-0086		1-edge tipped
	TCGT 16T304	9,525	3,97	0,40	DP1010-0087	DP2010-0087		1-edge tipped
	TCGT 16T308	9,525	3,97	0,80	DP1010-0088	DP2010-0088		1-edge tipped
	TCGT 16T312	9,525	3,97	1,20	DP1010-0089	DP2010-0089		1-edge tipped

Application range:

- PCD** Aluminum <10% Si, Brass, Brass lead-free, Graphite coarse-grained, Titanium (Roughing) ...
- CVD-D** Acrylic, Aluminum >10% Si, Carbide, Ceramics, Composites (CFRP, GFRP, MMC), Copper, Plastics, PEEK, Titanium (Finishing) ...
- UltraDia.** Glass Materials, Sintered Ceramic Materials, Carbides <12%Co, Carbides with Ni Binder, highly abrasive, difficult-to-machine materials ...

You will find further application ranges in the detailed overview on page 7.

TCGT - Chip Breaker

edge tipped



FN - neutral - Chip breaker for finishing (SPL-F) or roughing (SPL-R)

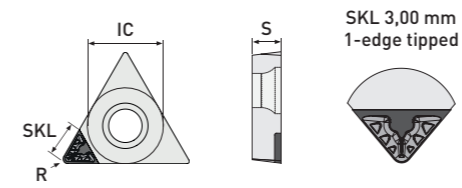

Standard	ISO Code	IC	S	R	SKL 3,00 mm 1-edge tipped		Version
					PKD Diamant Item No.	PKD Diamant Item No.	
					SPL-F (Finishing)	SPL-R (Roughing)	
	TCGT 090202	5,56	2,38	0,20	DP1011-0040	DP1012-0040	1-edge tipped
	TCGT 090204	5,56	2,38	0,40	DP1011-0041	DP1012-0041	1-edge tipped
	TCGT 090208	5,56	2,38	0,80	DP1011-0042	DP1012-0042	1-edge tipped
	TCGT 110202	6,35	2,38	0,20	DP1011-0043	DP1012-0043	1-edge tipped
	TCGT 110204	6,35	2,38	0,40	DP1011-0044	DP1012-0044	1-edge tipped
	TCGT 110208	6,35	2,38	0,80	DP1011-0045	DP1012-0045	1-edge tipped
	TCGT 16T302	9,525	3,97	0,20	DP1011-0046	DP1012-0046	1-edge tipped
	TCGT 16T304	9,525	3,97	0,40	DP1011-0047	DP1012-0047	1-edge tipped
	TCGT 16T308	9,525	3,97	0,80	DP1011-0048	DP1012-0048	1-edge tipped

Also available in CVD and CBN with Chip breaker on request.



Special tools on request for you!
Please send inquiries to info@Diamond-toolingsystems.com



All our products are also available in the online shop.
Visit us at Diamond-tools24.com



Scan me!

Subject to technical changes.

TCGT - Positive Rake Angle

entire edge

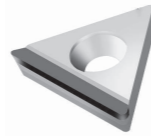

FN - Positive Rake Angle

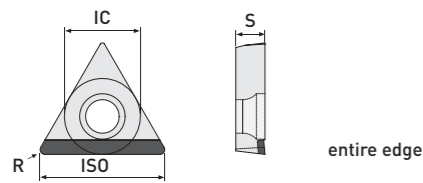

Standard	ISO Code	IC	S	R	PKD Diamant	CVD-D Diamant	Ultra Diamant	Version
					Item No.	Item No.	Item No.	
	TCGT 090202 GS	5,56	2,38	0,20	DP1020-0069	DP2020-0069		entire edge
	TCGT 090204 GS	5,56	2,38	0,40	DP1020-0021	DP2020-0021		entire edge
	TCGT 090208 GS	5,56	2,38	0,80	DP1020-0022	DP2020-0022		entire edge
	TCGT 110202 GS	6,35	2,38	0,20	DP1020-0070	DP2020-0070		entire edge
	TCGT 110204 GS	6,35	2,38	0,40	DP1020-0023	DP2020-0023		entire edge
	TCGT 110208 GS	6,35	2,38	0,80	DP1020-0024	DP2020-0024		entire edge
	TCGT 110212 GS	6,35	2,38	1,20	DP1020-0025	DP2020-0025		entire edge
	TCGT 16T302 GS	9,525	3,97	0,20	DP1020-0071	DP2020-0071		entire edge
	TCGT 16T304 GS	9,525	3,97	0,40	DP1020-0027	DP2020-0027		entire edge
	TCGT 16T308 GS	9,525	3,97	0,80	DP1020-0028	DP2020-0028		entire edge
	TCGT 16T312 GS	9,525	3,97	1,20	DP1020-0029	DP2020-0029		entire edge

TCGT - Chip Breaker

entire edge

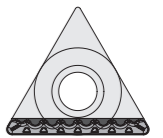

FN - neutral - Chip breaker for finishing (SPL-F) or roughing (SPL-R)

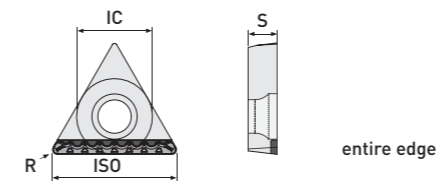

Standard	ISO Code	IC	S	R	PKD Diamant	PKD Diamant	Version
					Item No.	Item No.	
					SPL-F (Finishing)	SPL-R (Roughing)	
	TCGT 090202 GS	5,56	2,38	0,20	DP1021-0038	DP1022-0038	entire edge
	TCGT 090204 GS	5,56	2,38	0,40	DP1021-0012	DP1022-0012	entire edge
	TCGT 090208 GS	5,56	2,38	0,80	DP1021-0013	DP1022-0013	entire edge
	TCGT 110202 GS	6,35	2,38	0,20	DP1021-0039	DP1022-0039	entire edge
	TCGT 110204 GS	6,35	2,38	0,40	DP1021-0014	DP1022-0014	entire edge
	TCGT 110208 GS	6,35	2,38	0,80	DP1021-0015	DP1022-0015	entire edge
	TCGT 16T302 GS	9,525	3,97	0,20	DP1021-0040	DP1022-0040	entire edge
	TCGT 16T304 GS	9,525	3,97	0,40	DP1021-0018	DP1022-0018	entire edge
	TCGT 16T308 GS	9,525	3,97	0,80	DP1021-0019	DP1022-0019	entire edge

Also available in CVD and CBN with Chip breaker on request.

Application range:

- PCD Aluminum <10% Si, Brass, Brass lead-free, Graphite coarse-grained, Titanium (Roughing) ...
- CVD-D Acrylic, Aluminum >10% Si, Carbide, Ceramics, Composites (CFRP, GFRP, MMC), Copper, Plastics, PEEK, Titanium (Finishing) ...
- UltraDia. Glass Materials, Sintered Ceramic Materials, Carbides <12%Co, Carbides with Ni Binder, highly abrasive, difficult-to-machine materials ...

You will find further application ranges in the detailed overview on page 7.



Special tools on request for you!
Please send inquiries to info@Diamond-toolingsystems.com



All our products are also available in the online shop.
Visit us at Diamond-tools24.com



Scan me!

Subject to technical changes.

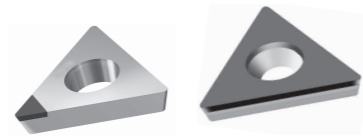

FN - neutral

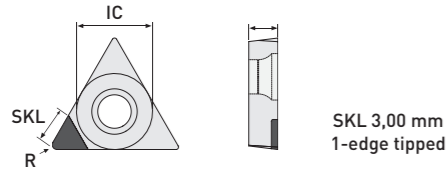

Standard	ISO Code	IC	S	R	PKD Diamant	CVD-D Diamant	Ultra Diamant	Version
					Item No.	Item No.	Item No.	
	TCGW 090201	5,56	2,38	0,10	DP1010-0613	DP2010-0613		1-edge tipped
	TCGW 090202	5,56	2,38	0,20	DP1010-0090	DP2010-0090		1-edge tipped
	TCGW 090204	5,56	2,38	0,40	DP1010-0091	DP2010-0091		1-edge tipped
	TCGW 090208	5,56	2,38	0,80	DP1010-0092	DP2010-0092		1-edge tipped
	TCGW 110201	6,35	2,38	0,10	DP1010-0614	DP2010-0614		1-edge tipped
	TCGW 110202	6,35	2,38	0,20	DP1010-0093	DP2010-0093		1-edge tipped
	TCGW 110204	6,35	2,38	0,40	DP1010-0094	DP2010-0094		1-edge tipped
	TCGW 110208	6,35	2,38	0,80	DP1010-0095	DP2010-0095		1-edge tipped
	TCGW 16T302	9,525	3,97	0,20	DP1010-0096	DP2010-0096		1-edge tipped
	TCGW 16T304	9,525	3,97	0,40	DP1010-0097	DP2010-0097		1-edge tipped
	TCGW 16T308	9,525	3,97	0,80	DP1010-0098	DP2010-0098		1-edge tipped
	TCGW 16T312	9,525	3,97	1,20	DP1010-0099	DP2010-0099		1-edge tipped

FN - FullFace

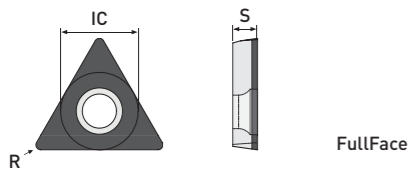

Standard	ISO Code	IC	S	R	PKD Diamant	CVD-D Diamant	Ultra Diamant	Version
					Item No.	Item No.	Item No.	
	TCGW 090202 FF	5,56	2,38	0,20	DP1030-0030	DP2030-0030		FullFace
	TCGW 090204 FF	5,56	2,38	0,40	DP1030-0031	DP2030-0031		FullFace
	TCGW 090208 FF	5,56	2,38	0,80	DP1030-0032	DP2030-0032		FullFace
	TCGW 110202 FF	6,35	2,38	0,20	DP1030-0010	DP2030-0010		FullFace
	TCGW 110204 FF	6,35	2,38	0,40	DP1030-0011	DP2030-0011		FullFace
	TCGW 110208 FF	6,35	2,38	0,80	DP1030-0012	DP2030-0012		FullFace

Application range:

- PCD Aluminum <10% Si, Brass, Brass lead-free, Graphite coarse-grained, Titanium (Roughing) ...
- CVD-D Acrylic, Aluminum >10% Si, Carbide, Ceramics, Composites (CFRP, GFRP, MMC), Copper, Plastics, PEEK, Titanium (Finishing) ...
- UltraDia. Glass Materials, Sintered Ceramic Materials, Carbides <12%Co, Carbides with Ni Binder, highly abrasive, difficult-to-machine materials ...

You will find further application ranges in the detailed overview on page 7.

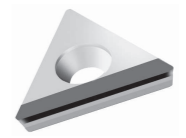

FN - neutral

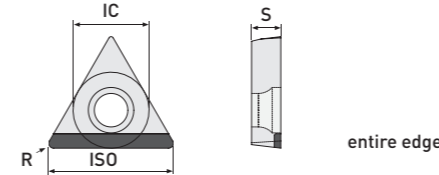

Standard	ISO Code	IC	S	R	PKD Diamant	CVD-D Diamant	Ultra Diamant	Version
					Item No.	Item No.	Item No.	
	TCGW 090202 GS	5,56	2,38	0,20	DP1020-0072	DP2020-0072		entire edge
	TCGW 090204 GS	5,56	2,38	0,40	DP1020-0030	DP2020-0030		entire edge
	TCGW 090208 GS	5,56	2,38	0,80	DP1020-0031	DP2020-0031		entire edge
	TCGW 110202 GS	6,35	2,38	0,20	DP1020-0073	DP2020-0073		entire edge
	TCGW 110204 GS	6,35	2,38	0,40	DP1020-0032	DP2020-0032		entire edge
	TCGW 110208 GS	6,35	2,38	0,80	DP1020-0033	DP2020-0033		entire edge
	TCGW 110212 GS	6,35	2,38	1,20	DP1020-0034	DP2020-0034		entire edge
	TCGW 16T302 GS	9,525	3,97	0,20	DP1020-0074	DP2020-0074		entire edge
	TCGW 16T304 GS	9,525	3,97	0,40	DP1020-0036	DP2020-0036		entire edge
	TCGW 16T308 GS	9,525	3,97	0,80	DP1020-0037	DP2020-0037		entire edge
	TCGW 16T312 GS	9,525	3,97	1,20	DP1020-0038	DP2020-0038		entire edge



Special tools on request for you!
Please send inquiries to info@Diamond-toolingsystems.com



All our products are also available in the online shop.
Visit us at Diamond-tools24.com



Scan me!

Subject to technical changes.

TPGN

edge tipped



FN - neutral

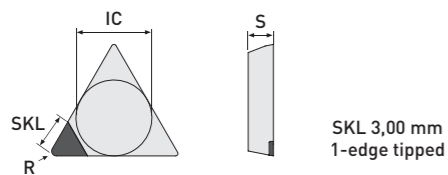

	ISO Code	IC	S	R	Diamant			Version
					PKD	CVD-D	Ultra	
	Item No.	Item No.	Item No.					
Standard	TPGN 090204	5,56	2,38	0,40	DP1010-0100	DP2010-0100		1-edge tipped
	TPGN 090208	5,56	2,38	0,80	DP1010-0101	DP2010-0101		1-edge tipped
	TPGN 110204	6,35	2,38	0,40	DP1010-0102	DP2010-0102		1-edge tipped
	TPGN 110208	6,35	2,38	0,80	DP1010-0103	DP2010-0103		1-edge tipped
	TPGN 110302	6,35	3,18	0,20	DP1010-0104	DP2010-0104		1-edge tipped
	TPGN 110304	6,35	3,18	0,40	DP1010-0105	DP2010-0105		1-edge tipped
	TPGN 110308	6,35	3,18	0,80	DP1010-0106	DP2010-0106		1-edge tipped
	TPGN 160304	9,525	3,18	0,40	DP1010-0107	DP2010-0107		1-edge tipped
	TPGN 160308	9,525	3,18	0,80	DP1010-0108	DP2010-0108		1-edge tipped
	TPGN 160312	9,525	3,18	1,20	DP1010-0109	DP2010-0109		1-edge tipped

TPGN

entire edge



FN - neutral

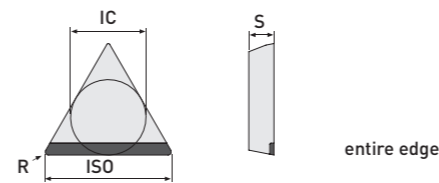

	ISO Code	IC	S	R	Diamant			Version
					PKD	CVD-D	Ultra	
	Item No.	Item No.	Item No.					
Standard	TPGN 110304 GS	6,35	3,18	0,40	DP1020-0039	DP2020-0039		entire edge
	TPGN 110308 GS	6,35	3,18	0,80	DP1020-0040	DP2020-0040		entire edge
	TPGN 110312 GS	6,35	3,18	1,20	DP1010-0041	DP2010-0041		entire edge
	TPGN 160304 GS	9,525	3,18	0,40	DP1020-0042	DP2020-0042		entire edge
	TPGN 160308 GS	9,525	3,18	0,80	DP1020-0043	DP2020-0043		entire edge
	TPGN 160312 GS	9,525	3,18	1,20	DP1020-0044	DP2020-0044		entire edge

TPGW

edge tipped

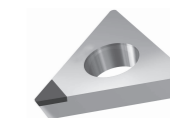

FN - neutral

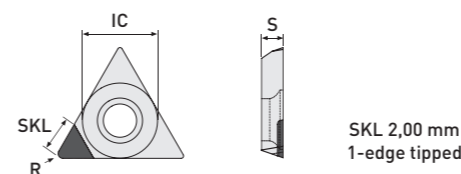

	ISO Code	IC	S	R	Diamant			Version
					PKD	CVD-D	Ultra	
	Item No.	Item No.	Item No.					
MiniTools	TPGW 06T101	3,97	1,98	0,10		DP2010-0671	DP1110-1410	1-edge tipped
	TPGW 06T102	3,97	1,98	0,20		DP2010-0672	DP1110-1412	1-edge tipped
	TPGW 06T104	3,97	1,98	0,40		DP2010-0673	DP1110-1414	1-edge tipped

! You will find the matching MiniTool holder in our boring bar catalog [03] on page 28.

Application range:

- PCD Aluminum <10% Si, Brass, Brass lead-free, Graphite coarse-grained, Titanium (Roughing) ...
- CVD-D Acrylic, Aluminum >10% Si, Carbide, Ceramics, Composites (CFRP, GFRP, MMC), Copper, Plastics, PEEK, Titanium (Finishing) ...
- UltraDia. Glass Materials, Sintered Ceramic Materials, Carbides <12%Co, Carbides with Ni Binder, highly abrasive, difficult-to-machine materials ...

You will find further application ranges in the detailed overview on page 7.



Special tools on request for you!
Please send inquiries to info@diamond-toolingsystems.com



All our products are also available in the online shop.
Visit us at Diamond-tools24.com



Scan me!

Subject to technical changes.

VBGT - Positive Rake Angle

edge tipped

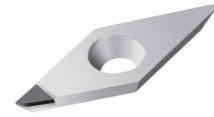

FN - Positive Rake Angle

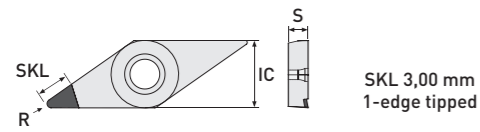

	ISO Code	IC	S	R	Diamant			Version
					PKD	CVD-D	Ultra	
	Item No.	Item No.	Item No.					
Standard	VBGT 110201	6,35	2,38	0,10	DP1010-0605	DP2010-0605		1-edge tipped
	VBGT 110202	6,35	2,38	0,20	DP1010-0401	DP2010-0401		1-edge tipped
	VBGT 110204	6,35	2,38	0,40	DP1010-0402	DP2010-0402		1-edge tipped
	VBGT 110208	6,35	2,38	0,80	DP1010-0403	DP2010-0403		1-edge tipped
	VBGT 160401	9,525	4,76	0,10	DP1010-0606	DP2010-0606		1-edge tipped
	VBGT 160402	9,525	4,76	0,20	DP1010-0404	DP2010-0404		1-edge tipped
	VBGT 160404	9,525	4,76	0,40	DP1010-0405	DP2010-0405		1-edge tipped
	VBGT 160408	9,525	4,76	0,80	DP1010-0406	DP2010-0406		1-edge tipped
	VBGT 160412	9,525	4,76	1,20	DP1010-0407	DP2010-0407		1-edge tipped

VBGW

edge tipped

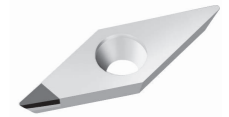

FN - neutral

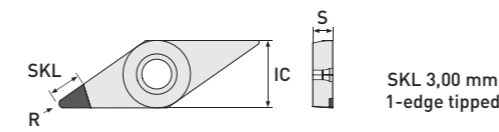

	ISO Code	IC	S	R	Diamant			Version
					PKD	CVD-D	Ultra	
	Item No.	Item No.	Item No.					
Standard	VBGW 110201	6,35	2,38	0,10	DP1010-0607	DP2010-0607		1-edge tipped
	VBGW 110202	6,35	2,38	0,20	DP1010-0451	DP2010-0451		1-edge tipped
	VBGW 110204	6,35	2,38	0,40	DP1010-0452	DP2010-0452		1-edge tipped
	VBGW 110208	6,35	2,38	0,80	DP1010-0453	DP2010-0453		1-edge tipped
	VBGW 160401	9,525	4,76	0,10	DP1010-0608	DP2010-0608		1-edge tipped
	VBGW 160402	9,525	4,76	0,20	DP1010-0454	DP2010-0454		1-edge tipped
	VBGW 160404	9,525	4,76	0,40	DP1010-0455	DP2010-0455		1-edge tipped
	VBGW 160408	9,525	4,76	0,80	DP1010-0456	DP2010-0456		1-edge tipped
	VBGW 160412	9,525	4,76	1,20	DP1010-0457	DP2010-0457		1-edge tipped

Application range:

- PCD** Aluminum <10% Si, Brass, Brass lead-free, Graphite coarse-grained, Titanium (Roughing) ...
- CVD-D** Acrylic, Aluminum >10% Si, Carbide, Ceramics, Composites (CFRP, GFRP, MMC), Copper, Plastics, PEEK, Titanium (Finishing) ...
- UltraDia.** Glass Materials, Sintered Ceramic Materials, Carbides <12%Co, Carbides with Ni Binder, highly abrasive, difficult-to-machine materials ...

You will find further application ranges in the detailed overview on page 7.



Special tools on request for you!
Please send inquiries to info@Diamond-toolingsystems.com



All our products are also available in the online shop.
Visit us at Diamond-tools24.com



Scan me!

Subject to technical changes.

VCGT - Positive Rake Angle

edge tipped

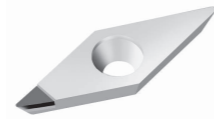

FN - Positive Rake Angle

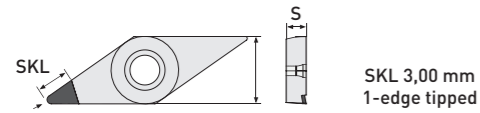

Standard	ISO Code	IC	S	R	PKD Diamant	CVD-D Diamant	Ultra Diamant	Version
					Item No.	Item No.	Item No.	
	VCGT 070201	3,97	2,38	0,10	DP1010-0131	DP2010-0133		1-edge tipped
	VCGT 070202	3,97	2,38	0,20	DP1010-0119	DP2010-0119		1-edge tipped
	VCGT 070204	3,97	2,38	0,40	DP1010-0120	DP2010-0120		1-edge tipped
	VCGT 070208	3,97	2,38	0,80	DP1010-0132	DP2010-0134		1-edge tipped
	VCGT 110301	6,35	3,18	0,10	DP1010-0609	DP2010-0609		1-edge tipped
	VCGT 110302	6,35	3,18	0,20	DP1010-0121	DP2010-0121		1-edge tipped
	VCGT 110304	6,35	3,18	0,40	DP1010-0122	DP2010-0122		1-edge tipped
	VCGT 110308	6,35	3,18	0,80	DP1010-0123	DP2010-0123		1-edge tipped
	VCGT 160401	9,525	4,76	0,10	DP1010-0610	DP2010-0610		1-edge tipped
	VCGT 160402	9,525	4,76	0,20	DP1010-0124	DP2010-0124		1-edge tipped
	VCGT 160404	9,525	4,76	0,40	DP1010-0125	DP2010-0125		1-edge tipped
	VCGT 160408	9,525	4,76	0,80	DP1010-0126	DP2010-0126		1-edge tipped
	VCGT 160412	9,525	4,76	1,20	DP1010-0127	DP2010-0127		1-edge tipped

Standard

Application range:

- PCD Aluminum <10% Si, Brass, Brass lead-free, Graphite coarse-grained, Titanium (Roughing) ...
- CVD-D Acrylic, Aluminum >10% Si, Carbide, Ceramics, Composites (CFRP, GFRP, MMC), Copper, Plastics, PEEK, Titanium (Finishing) ...
- UltraDia. Glass Materials, Sintered Ceramic Materials, Carbides <12%Co, Carbides with Ni Binder, highly abrasive, difficult-to-machine materials ...

You will find further application ranges in the detailed overview on page 7.

VCGT - Chip Breaker

edge tipped



FN - neutral - Chip breaker for finishing (SPL-F) or roughing (SPL-R)

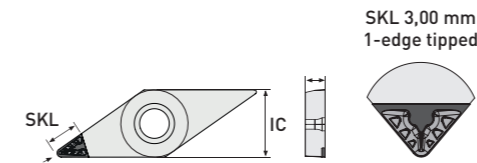

Standard	ISO Code	IC	S	R	PKD Diamant	PKD Diamant	Version
					Item No.	Item No.	
					SPL-F (Finishing)	SPL-R (Roughing)	
	VCGT 070202	3,97	2,38	0,20	DP1011-0060	DP1012-0060	1-edge tipped
	VCGT 070204	3,97	2,38	0,40	DP1011-0061	DP1012-0061	1-edge tipped
	VCGT 070208	3,97	2,38	0,80	DP1011-0075	DP1012-0075	1-edge tipped
	VCGT 110302	6,35	3,18	0,20	DP1011-0062	DP1012-0062	1-edge tipped
	VCGT 110304	6,35	3,18	0,40	DP1011-0063	DP1012-0063	1-edge tipped
	VCGT 110308	6,35	3,18	0,80	DP1011-0064	DP1012-0064	1-edge tipped
	VCGT 160402	9,525	4,76	0,20	DP1011-0065	DP1012-0065	1-edge tipped
	VCGT 160404	9,525	4,76	0,40	DP1011-0066	DP1012-0066	1-edge tipped
	VCGT 160408	9,525	4,76	0,80	DP1011-0067	DP1012-0067	1-edge tipped

Standard

Also available in CVD and CBN with Chip breaker on request.



Special tools on request for you!
Please send inquiries to info@Diamond-toolingsystems.com



All our products are also available in the online shop.
Visit us at Diamond-tools24.com



Scan me!

Subject to technical changes.

VCGW

edge tipped

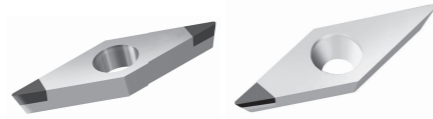

FN - neutral

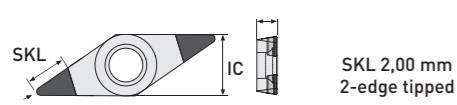

	ISO Code	IC	S	R	Diamant			Version
					PKD	CVD-D	Ultra	
MiniTools	VCGW 050101	3,10	1,59	0,10		DP2010-0561	DP1110-1498	2-edge tipped
	VCGW 050102	3,10	1,59	0,20		DP2010-0562	DP1110-1500	2-edge tipped
	VCGW 050104	3,10	1,59	0,40		DP2010-0563	DP1110-1502	2-edge tipped

! You will find the matching MiniTool holder in our boring bar catalog (03) on page 29.

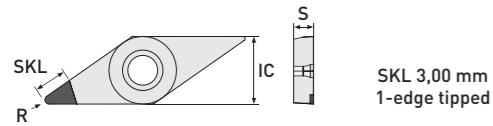

	ISO Code	IC	S	R	Diamant			Version
					PKD	CVD-D	Ultra	
Standard	VCGW 070201	3,97	2,38	0,10		DP1010-0135	DP2010-0135	1-edge tipped
	VCGW 070202	3,97	2,38	0,20		DP1010-0110	DP2010-0110	1-edge tipped
	VCGW 070204	3,97	2,38	0,40		DP1010-0111	DP2010-0111	1-edge tipped
	VCGW 070208	3,97	2,38	0,80		DP1010-0136	DP2010-0136	1-edge tipped
	VCGW 110301	6,35	3,18	0,10		DP1010-0611	DP2010-0611	1-edge tipped
	VCGW 110302	6,35	3,18	0,20		DP1010-0112	DP2010-0112	1-edge tipped
	VCGW 110304	6,35	3,18	0,40		DP1010-0113	DP2010-0113	1-edge tipped
	VCGW 110308	6,35	3,18	0,80		DP1010-0114	DP2010-0114	1-edge tipped
	VCGW 160401	9,525	4,76	0,10		DP1010-0612	DP2010-0612	1-edge tipped
	VCGW 160402	9,525	4,76	0,20		DP1010-0115	DP2010-0115	1-edge tipped
	VCGW 160404	9,525	4,76	0,40		DP1010-0116	DP2010-0116	1-edge tipped
	VCGW 160408	9,525	4,76	0,80		DP1010-0117	DP2010-0117	1-edge tipped
	VCGW 160412	9,525	4,76	1,20		DP1010-0118	DP2010-0118	1-edge tipped

Application range:

- PKD** Aluminum <10% Si, Brass, Brass lead-free, Graphite coarse-grained, Titanium (Roughing) ...
- CVD-D** Acrylic, Aluminum >10% Si, Carbide, Ceramics, Composites (CFRP, GFRP, MMC), Copper, Plastics, PEEK, Titanium (Finishing) ...
- UltraDia.** Glass Materials, Sintered Ceramic Materials, Carbides <12%Co, Carbides with Ni Binder, highly abrasive, difficult-to-machine materials ...

You will find further application ranges in the detailed overview on page 7.

VXGW

edge tipped



FN - neutral

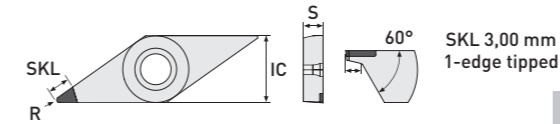

	ISO Code	IC	S	R	Diamant			Version
					PKD	CVD-D	Ultra	
DTS - Specials	VXGW 160401	9,525	4,76	0,10		DP2010-0310		1-edge tipped
	VXGW 160402	9,525	4,76	0,20		DP2010-0311		1-edge tipped
	VXGW 160404	9,525	4,76	0,40		DP2010-0312		1-edge tipped
	VXGW 160408	9,525	4,76	0,80		DP2010-0313		1-edge tipped

! The matching holders on request, available from stock.

DTS-Specials Plan/Axial Machining:

Our VXGW cutting insert is designed for face and axial machining of contours from a minimum outside diameter of 10mm, using the maximum groove depth of 1.5mm.

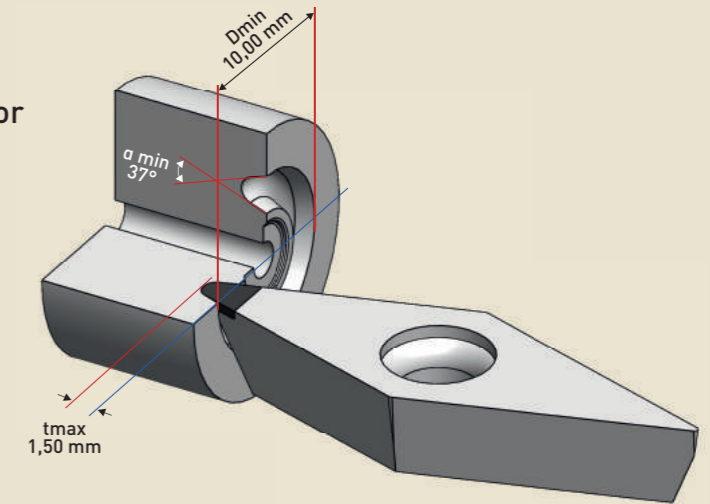

It is tipped with CVD-D as standard, but is of course also available with PCD or Ultra-Diamond on request.



Special tools on request for you!
Please send inquiries to info@Diamond-toolingsystems.com



All our products are also available in the online shop.
Visit us at Diamond-tools24.com



Scan me!

Subject to technical changes.



FN - neutral

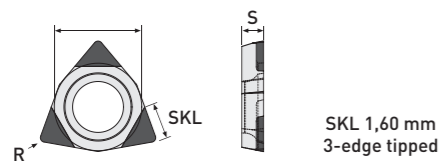

SKL 1,60 mm
3-edge tipped



MiniTools	ISO Code	IC	S	R	Item No.	Item No.	Item No.	Version
	WCGW 020101	3,97	1,59	0,10		DP2010-0571	DP1110-1504	3-edge tipped
WCGW 020102	3,97	1,59	0,20		DP2010-0572	DP1110-1506	3-edge tipped	
WCGW 020104	3,97	1,59	0,40		DP2010-0573	DP1110-1508	3-edge tipped	

! You will find the matching MiniTool holder in our boring bar catalog (03) on page 34.

Application range:

- PCD Aluminum <10% Si, Brass, Brass lead-free, Graphite coarse-grained, Titanium (Roughing) ...
- CVD-D Acrylic, Aluminum >10% Si, Carbide, Ceramics, Composites (CFRP, GFRP, MMC), Copper, Plastics, PEEK, Titanium (Finishing) ...
- UltraDia. Glass Materials, Sintered Ceramic Materials, Carbides <12%Co, Carbides with Ni Binder, highly abrasive, difficult-to-machine materials ...

You will find further application ranges in the detailed overview on page 7.

Cutting Parameters

for our Diamond indexable inserts

Material	Diamond Indexable Inserts											
	PCD						CVD-D					
	V_c [m/min]		a_p [mm]		F [mm/U]		V_c [m/min]		a_p [mm]		F [mm/U]	
	min.	max.	min.	max.	min.	max.	min.	max.	min.	max.	min.	max.
Acryl (PMMA)	100	2.000	0,01	2,80	0,01	0,40	200	5.000	0,01	2,60	0,01	0,50
Al Si <10%	300	3.000	0,01	2,80	0,01	0,50	200	5.000	0,01	2,80	0,01	0,60
Al Si >10%							150	4.000	0,01	2,80	0,01	0,40
Graphit	150	1.000	0,01	2,80	0,02	0,50	80	1.500	0,01	2,80	0,01	0,60
Gold, Silver, Platin							80	3.000	0,01	2,60	0,01	0,50
Glas, GlasCeramic	on request											
Carbide G-Type <15% Co												
Carbide G-Type >15% Co												
Carbide K-Type <15% Co												
Carbide K-Type >15% Co												
Carbide with Ni-Binder												
Ceramics, Zirconium												
Plastics							100	1.500	0,01	2,80	0,01	0,60
Copper, Copper Alloy	100	2.000	0,01	2,60	0,01	0,40	60	3.500	0,01	2,60	0,005	0,60
Magnesium	200	3.000	0,01	2,80	0,01	0,30	80	4.500	0,01	2,60	0,01	0,40
Brass, Brass lead-free	120	2.000	0,01	2,60	0,01	0,40	80	3.000	0,01	2,60	0,01	0,50
PEEK	80	3.000	0,01	2,60	0,01	0,50						
Titanium	80	150	0,01	0,50	0,01	0,30	100	200	0,01	0,50	0,01	0,40
Composites Materials GFK / CFK / MMC							80	3.000	0,01	2,60	0,01	0,50
Tungsten Copper							40	1.200	0,01	2,00	0,01	0,30

Subject to technical changes.

Diamond Indexable Inserts											
UltraDiamond						Cooling					
V_c [m/min]		a_p [mm]		F [mm/U]		Dry	Air	Emulsion	Oil	ML	
min.	max.	min.	max.	min.	max.						
80	5.000	0,01	2,60	0,005	0,50	5. Choice	4. Choice	1. Choice	2. Choice	3. Choice	
						5. Choice	4. Choice	1. Choice	2. Choice	3. Choice	
								1. Choice	2. Choice	3. Choice	
						2. Choice	1. Choice				
							3. Choice	1. Choice		2. Choice	
						on request					
							3. Choice	1. Choice		2. Choice	
							4. Choice	1. Choice	2. Choice	3. Choice	
							4. Choice	1. Choice	2. Choice	3. Choice	
						5. Choice	4. Choice	1. Choice	2. Choice	3. Choice	
							4. Choice	1. Choice	2. Choice	3. Choice	
							4. Choice	1. Choice	2. Choice	3. Choice	
						4. Choice	1. Choice	2. Choice		3. Choice	
							3. Choice	1. Choice		2. Choice	

Cutting Parameters

for our Diamond inserts with Chip breaker



		Chip Breaker											
		Chip breaker F (Finishing chip breaker)						Chip breaker R (Roughing chip breaker)					
Material	R	V _c [m/min]		a _p [mm]		F [mm/U]		V _c [m/min]		a _p [mm]		F [mm/U]	
		min.	max.	min.	max.	min.	max.	min.	max.	min.	max.	min.	max.
AlSi <3%	0,2	100	800	0,01	2,00	0,02	0,10	100	800	0,12	2,80	0,03	0,10
	0,4	100	800	0,01	2,00	0,04	0,20	100	800	0,12	2,80	0,03	0,20
	0,8	100	800	0,01	2,00	0,05	0,40	100	800	0,12	2,80	0,06	0,40
	1,2	100	800	0,01	2,00	0,05	0,40	100	800	0,12	2,80	0,08	0,60
AlSi <12%	0,2	80	600	0,01	2,00	0,02	0,10	80	800	0,12	2,80	0,08	0,10
	0,4	80	600	0,01	2,00	0,04	0,20	80	800	0,12	2,80	0,10	0,20
	0,8	80	600	0,01	2,00	0,05	0,40	80	800	0,15	2,80	0,15	0,40
	1,2	80	600	0,01	2,00	0,05	0,60	80	800	0,20	2,80	0,20	0,60
Copper, Bronze	0,2	80	600	0,01	2,00	0,02	0,10	80	600	0,12	2,80	0,08	0,10
	0,4	80	600	0,01	2,00	0,04	0,20	80	600	0,15	2,80	0,10	0,20
	0,8	80	600	0,01	2,00	0,05	0,40	80	600	0,15	2,80	0,20	0,40
	1,2	80	600	0,01	2,00	0,05	0,60	80	600	0,20	2,80	0,25	0,60
Brass lead-free	0,2	80	600	0,01	2,00	0,02	0,10	80	600	0,12	2,80	0,05	0,10
	0,4	80	800	0,01	2,00	0,04	0,20	80	800	0,12	2,80	0,07	0,20
	0,8	80	800	0,01	2,00	0,05	0,40	80	800	0,15	2,80	0,07	0,40
	1,2	80	800	0,01	2,00	0,05	0,60	80	800	0,20	2,80	0,12	0,60
MMC	0,2	100	500	0,01	2,00	0,02	0,10	100	500	0,12	2,80	0,05	0,10
	0,4	100	500	0,01	2,00	0,04	0,20	100	500	0,12	2,80	0,06	0,20
	0,8	100	500	0,01	2,00	0,05	0,40	100	500	0,20	2,80	0,10	0,40
	1,2	100	500	0,01	2,00	0,05	0,60	100	500	0,25	2,80	0,15	0,60

Cooling recommended

In machining with Diamond inserts, the right cooling is a key to successful machining.

Here you will find our recommendation:

Material	Cooling				
	Dry	Air	Emulsion	Oil	MQL
AlSi <3%			1. Choice	2. Choice	3. Choice
AlSi <12%			1. Choice	2. Choice	3. Choice
Copper, Bronze			1. Choice	2. Choice	3. Choice
Brass lead free	5. Choice	4. Choice	1. Choice	2. Choice	3. Choice
MMC		2. Choice	1. Choice		



If you have any further technical questions, please do not hesitate to contact us
by phone or e-mail!

Phone: +49(0)6301 32011-0

Mail: info@Diamond-toolingsystems.com

Formulas

Turning

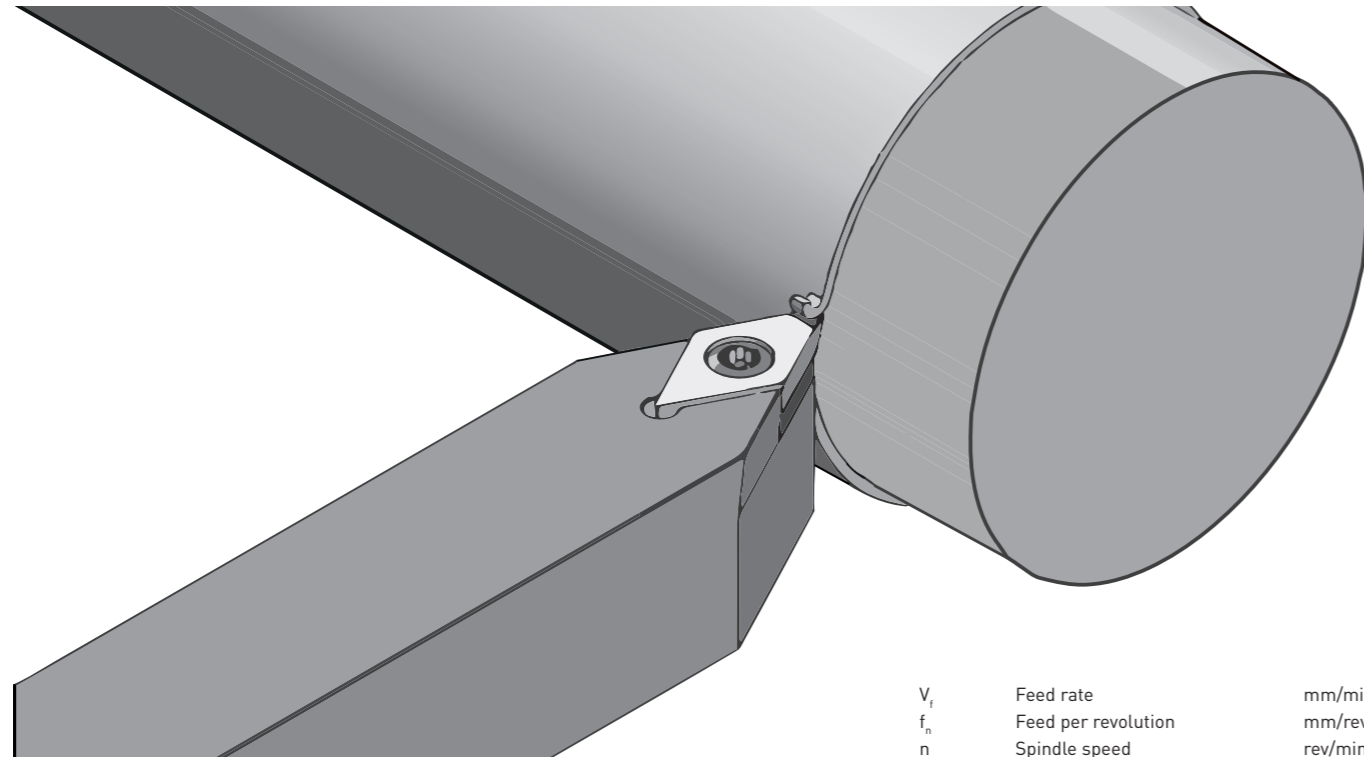

V_f	Feed rate	mm/min
f_n	Feed per revolution	mm/rev
n	Spindle speed	rev/min
v_c	Cutting speed	m/min
D_c	Cutter diameter	mm
t_c	Cutting Time	min
l_m	Cutting length	mm
Q	Stock removal rate	cm ³ /min
a_p	Cutting depth	mm

▶ Cutting speed

$$V_c = \frac{D_c \times \pi \times n}{1000} \quad [\text{m/min}]$$

▶ Spindle speed

$$n = \frac{v_c \times 1000}{\pi \times D_c} \quad [\text{U/min}]$$

▶ Feed per revolution

$$f_n = \frac{V_f}{n} \quad [\text{mm/U}]$$

▶ Cutting time

$$t_c = \frac{l_m}{f_n \times n} \quad [\text{min}]$$

▶ Stock removal rate

$$Q = v_c \times a_p \times f_n \quad [\text{cm}^3/\text{min}]$$

Your Notes

A large grid area for taking notes, consisting of a 20x30 grid of small squares.



Instagram



YouTube



LinkedIn



DTS Shop



DTS Webseite



PASSION FOR DIAMOND

Hans-Geiger-Straße 11a · D-67661 Kaiserslautern

+49 (0) 6301 32011-0

+49 (0) 6301 32011-90

info@Diamond-toolingsystems.com

Homepage: www.Diamond-toolingsystems.com

Shop: www.Diamond-tools24.com